

車種 Model 383W	設変切替依頼書 ENGINEERING CHANGE INSTRUCTIONS No.1	承認(P/M) Approved	担当設計室 Eng. Design	承認 Approved	調査 Checked	客先No. Customer No. 作成 Prepared	383WPO580/0406/0627/0618	
			TBA24	安藤	中根	No.	383WAF0150	
		Date	Date	06.12.22	06.12.21	'06.12.20	TEL	5766

要旨 Purpose	切替に対する希望・条件 Change Condition Requested by Engineer	事前連絡 Advance Notice	R/C, F/F切替制約 Restriction on Change over Timing Concerning Certification	共用先 Common	関係先 Related
仕様変更/Specification Change 3RD BACK FRAME 構成部品変更します。	1次号から/From 1A A) 単独/Independent Change	TMI 神谷殿 新進 小畑殿	無し/Unrestricted		

Key	Model	Group	Variation/Block Code	Key	Model	Group	Variation/Block Code	Key	Model	Group	Variation/Block Code
001	383W	7100AC	K-NA								
002	383W	7100AC	K-NB								
003	383W	7100AC	K-PA								
004	383W	7100AC	K-PA, K-PB								
005	383W	7100AC	K-PB								
006	383W	7100AC	P-NA								
007	383W	7100AC	P-NA, P-NB, P-PA, P-PB								
008	383W	7100AC	P-NA, P-PA								
009	383W	7100AC	P-NB								
010	383W	7100AC	P-NB, P-PB								
011	383W	7100AC	P-PA								
012	383W	7100AC	P-PB								

車種 383W
Model

設変切替依頼書 No.2

ENGINEERING CHANGE INSTRUCTIONS No.2

互換性 Interchangeability
 旧PP 互NP
 PP A:PVO NVO NP X:PVO NVO
 PP B:PVO NVA NP Y123:
 PP C:PVO NVX PVA NVO
 PP D:PVX NVX NP Z:PVX NVO
 C,Y,Z→Type Major

No. 383WAF0150
 Page 2 / 12

No.	工程 Routing (Process)	区分 Key	レベル Lvl	GC 色 Color	旧品番 Previous Part No. 新品番 New Part No.	品名 Part Name	選択 個数 St	Condi tion	認証 Regu 補給 Ser.	変更事項 Revision		出図Dwg. CAD	出図予定 Dwg. Issue 出図コメント Dwg. Com	旧PP 互NP
										概要 Apply	共用先 Comm			
1		001	01	✓	71293-X7C01 71293-X7C01- A	PLATE, RR SEAT BACK, UPR				形状変更/Shape Change マイナ変更/Minor E/C		0 N		A X
2		001	01	✓	71295-X7C03- A 71295-X7C03- B	PLATE, RR SEAT BACK UPR SIDE, RH				形状変更/Shape Change マイナ変更/Minor E/C		0 N		A X
3		001	01	✓	71295-X7C04- A 71295-X7C04- B	PLATE, RR SEAT BACK UPR SIDE, RH				形状変更/Shape Change マイナ変更/Minor E/C		0 N		A X
4		001	01	✓	79303-0C010- D 79303-0C010- G	FRAME SUB-ASSY, NO. 3 SEAT BACK, RH				構成部品変更/Component Part Change マイナ変更/Minor E/C		0 N		A X
5		001	02		71167-44010- D 71167-44010- D	BRACKET, FR SEAT BAC K HEADREST SET, RH	2			個数変更/Quantity Change 1個→2個		X N		A X
6										同左/No Change				
7		001	02		71168-44010- D	BRACKET, FR SEAT BAC K HEADREST SET, LH	1					X N		A X
8		002	01	✓	71293-X7C04 71293-X7C04- A	PLATE, RR SEAT BACK, UPR				形状変更/Shape Change マイナ変更/Minor E/C		0 N		A X
9		002	01	✓	71295-X7C05- A 71295-X7C05- B	PLATE, RR SEAT BACK UPR SIDE, RH				形状変更/Shape Change マイナ変更/Minor E/C		0 N		A X
10		002	01	✓	71295-X7C06- A 71295-X7C06- B	PLATE, RR SEAT BACK UPR SIDE, RH				形状変更/Shape Change マイナ変更/Minor E/C		0 N		A X
11		002	01	✓	79303-0C020- D 79303-0C020- H	FRAME SUB-ASSY, NO. 3 SEAT BACK, RH				構成部品変更/Component Part Change マイナ変更/Minor E/C		0 N		A X
12		002	02		71167-44010- D 71167-44010- D	BRACKET, FR SEAT BAC K HEADREST SET, RH	2			個数変更/Quantity Change 1個→2個		X N		A X
13										同左/No Change				
14		002	02		71168-44010- D	BRACKET, FR SEAT BAC K HEADREST SET, LH	1					X N		A X
15		003	01	✓	71293-X7C02 71293-X7C02- A	PLATE, RR SEAT BACK, UPR				形状変更/Shape Change マイナ変更/Minor E/C		0 N		A X
16		003	01	✓	71296-X7C03- A 71296-X7C03- B	PLATE, RR SEAT BACK UPR SIDE, LH				形状変更/Shape Change マイナ変更/Minor E/C		0 N		A X
17		003	01	✓	71296-X7C04- B 71296-X7C04- C	PLATE, RR SEAT BACK UPR SIDE, LH				形状変更/Shape Change マイナ変更/Minor E/C		0 N		A X
18		003	01	✓	79304-0C010- D 79304-0C010- G	FRAME SUB-ASSY, NO. 3 SEAT BACK, LH				構成部品変更/Component Part Change マイナ変更/Minor E/C		0 N		A X

車種 383W
Model

設変切替依頼書 No.2

ENGINEERING CHANGE INSTRUCTIONS No.2

互換性 Interchangeability

旧PP 互NP
PP A:PVO NVO NP X:PVO NVO
PP B:PVO NVΔ NP Y123:
PP C:PVO NVX PVD NVO
PP D:PVX NVX NP Z:PVX NVO
C,Y,Z→Type Major

No

383WAF0150

Page

3 / 12

No.	工程 Routing (Process)	区分 Key	レベル Lvl	GC 色 Color	旧品番 Previous Part No. 新品番 New Part No.	品名 Part Name	選択 個数 SI	Condi tion	承認 Regu 補給 Ser.	変更事項 Revision		出図Dwg.	出図予定 Dwg. Issue	旧PP
										概要 Apply	共用先 Common	CAD	出図コメント Dwg. Com	互NP
1		003	02		71167-44010- D 71167-44010- D	BRACKET, FR SEAT BAC K HEADREST SET, RH	3			個数変更/Quantity Change 2個→3個		X N		A X
2										同左/No Change				
3		003	02		71168-44010- D 71168-44010- D	BRACKET, FR SEAT BAC K HEADREST SET, LH	1			個数変更/Quantity Change 2個→1個		X N		A X
4										同左/No Change				
5		003	02		71267-X7C03	BRACKET, RR SEAT BAC K STOPPER, LH	1			使用廃止/Partical Disuse		X N		A X
6		003	02		71297-X1T01- A	WIRE, RR SEAT BACK	1			使用廃止/Partical Disuse		X N		A X
7		004	01	✓	71273-X7C00- B 71273-X7C00- C	PANEL, RR SEAT BACK				形状変更/Shape Change マイナ変更/Minor E/C		O N		A X
8		004	01	✓	71297-X7C07 71297-X7C07- A	WIRE, RR SEAT BACK				形状変更/Shape Change マイナ変更/Minor E/C		O N		A X
9		005	01	✓	71293-X7C03 71293-X7C03- A	PLATE, RR SEAT BACK, UPR				形状変更/Shape Change マイナ変更/Minor E/C		O N		A X
10		005	01	✓	71296-X7C06- A 71296-X7C06- B	PLATE, RR SEAT BACK UPR SIDE, LH				形状変更/Shape Change マイナ変更/Minor E/C		O N		A X
11		005	01	✓	79304-0C020- D 79304-0C020- H	FRAME SUB-ASSY, NO. 3 SEAT BACK, LH				構成部品変更/Component Part Change マイナ変更/Minor E/C		O N		A X
12		005	02		71167-44010- D 71167-44010- D	BRACKET, FR SEAT BAC K HEADREST SET, RH	3			個数変更/Quantity Change 2個→3個		X N		A X
13										同左/No Change				
14		005	02		71168-44010- D 71168-44010- D	BRACKET, FR SEAT BAC K HEADREST SET, LH	1			個数変更/Quantity Change 2個→1個		X N		A X
15										同左/No Change				
16		006	01		71930-42020- B	SUPPORT ASSY, FR SEA T HEADREST	1			使用廃止/Partical Disuse		X N		A X
17		006	01		71930-48010- A	SUPPORT ASSY, FR SEA T HEADREST	1			使用追加/Additonal Adoption		X N		A X
18		007	01	✓	71941-X7C00- A 71941-X7C00- B	STAY, RR SEAT HEADRE ST				形状変更/Shape Change マイナ変更/Minor E/C		O N		A X

車種 383W
Model

設変切替依頼書 No.2

ENGINEERING CHANGE INSTRUCTIONS No.2

互換性 Interchangeability

旧PP 互NP
PP A:PVO NVO NP X:PVO NVO
PP B:PVO NVΔ NP Y123:
PP C:PVO NVX PVA NVO
PP D:PVX NVX NP Z:PVX NVO
C,Y,Z→Type Major

No

383WAF0150

Page

4 / 12

No.	工程 Routing (Process)	区分 Key	レベル Lvl	GC 色 Color	旧品番 Previous Part No. 新品番 New Part No.	品名 Part Name	選択 個数 St	Condi tion	認識 和給 Ser.	変更事項 Revision		出図Dwg. CAD	出図予定 出図コメント Dwg. Issue Dwg. Com	旧PP 互NP
										概要 Apply	共用先 Commo			
1		007	01	✓	71941-X7C01 71941-X7C01- A	STAY, RR SEAT HEADRE ST						0 N		A X
2		007	01	✓	71953-X7C00- A 71953-X7C00- B	PAD, RR SEAT HEADRES T						0 N		A X
3		007	01	✓	71953-X7C01- A 71953-X7C01- B	PAD, RR SEAT HEADRES T						0 N		A X
4		008	01	✓	71097-0C040 71097-0C040- A	PAD SUB-ASSY, NO. 2 S EAT HEADREST						0 N		A X
5		008	01	✓	71907-0C020- B 71907-0C020- C	ADJUSTER SUB-ASSY, R R SEAT HEADREST						0 N		A X
6		008	01	✓	71952-X7C01 71952-X7C01- A	COVER, RR SEAT HEADR EST UNDER						0 N		A X
7														
8		008	02		71944-X7C02	PLATE, RR SEAT HEADR EST COVER	1					X N		A X
9		008	01	✓	71970-0C080 71970-0C080- A	HEADREST ASSY, NO. 2 SEAT						0 N		A X
10		009	01		71930-42020- B	SUPPORT ASSY, FR SEA T HEADREST	1					X N		A X
11		009	01		71930-48010- A	SUPPORT ASSY, FR SEA T HEADREST	1					X N		A X
12		009	01	✓	71097-0C050 71097-0C050- A	PAD SUB-ASSY, NO. 2 S EAT HEADREST						0 N		A X
13		009	01	✓	71907-0C030- B 71907-0C030- C	ADJUSTER SUB-ASSY, R R SEAT HEADREST						0 N		A X
14		009	02		71332-X7C03	PIN, RR SEAT HINGE, NO. 2	1					N N		A X
15		009	02		72622-X7C00	BUSH, RR SEAT BACK P ROTECTOR SHAFT	1					N N		A X
16		009	02		79712-X7C01	BUSH	1					N N		A X
17		009	01	✓	71970-0C110 71970-0C110- A	HEADREST ASSY, NO. 2 SEAT						0 N		A X
18		009	02		71952-X7C00	COVER, RR SEAT HEADR EST UNDER	1					N N		A X

車種 383W
Model

設変切替依頼書 No.2

ENGINEERING CHANGE INSTRUCTIONS No.2

互換性 Interchangeability

旧PP 互NP
PP A:PVO NV○ NP X:PVO NV○
PP B:PVO NV△ NP Y123:
PP C:PVO NV× PVA NV○
PP D:PV× NV× NP Z:PV× NV○
C,Y,Z→Type Major

No.

383WAF0150

Page

5 / 12

No.	工程 Routing (Process)	区分 Key	レベル Lvl	GC 色 Color	旧品番 Previous Part No. 新品番 New Part No.	品名 Part Name	選択 個数 St	Condi tion	認識 補給 Ser.	変更事項 Revision		出図Dwg. CAD	出図予定 出図コメント Dwg. Issue Dwg. Com	旧PP 互NP
										概要 Apply	共用先 Common			
1		009	03		71944-X7C02	PLATE, RR SEAT HEADR EST COVER	1			廃止/Total Disuse		N		A
2		009	02		71952-X7C01- A	COVER, RR SEAT HEADR EST UNDER	1			使用追加/Additonal Adoption		X		A
3		009	03		71944-X7C02	PLATE, RR SEAT HEADR EST COVER	1			廃止/Total Disuse		N		X
4		010	01	✓	71097-0C030 71097-0C030- A	PAD SUB-ASSY, NO. 2 S EAT HEADREST				構成部品変更/Component Part Change マイナ変更/Minor E/C		O		A
5		010	01	✓	71907-0C010- C 71907-0C010- D	ADJUSTER SUB-ASSY, R R SEAT HEADREST				構成部品変更/Component Part Change マイナ変更/Minor E/C		O		A
6		010	02		71332-X7C03	PIN, RR SEAT HINGE, NO. 2	1			廃止/Total Disuse		N		X
7		010	02		72622-X7C00	BUSH, RR SEAT BACK P ROTECTOR SHAFT	2			廃止/Total Disuse		N		X
8		010	02		79712-X7C01	BUSH	1			廃止/Total Disuse		N		X
9		010	01	✓	71970-0C090- A 71970-0C090- B	HEADREST ASSY, NO. 2 SEAT				構成部品変更/Component Part Change マイナ変更/Minor E/C		O		A
10		010	02		71952-X7C00	COVER, RR SEAT HEADR EST UNDER	1			廃止/Total Disuse		N		X
11		010	03		71944-X7C02	PLATE, RR SEAT HEADR EST COVER	1			廃止/Total Disuse		N		X
12		010	02		71952-X7C01- A	COVER, RR SEAT HEADR EST UNDER	1			使用追加/Additonal Adoption		X		A
13		010	03		71944-X7C02	PLATE, RR SEAT HEADR EST COVER	1			廃止/Total Disuse		N		X
14		011	01		71930-42020- B 71930-42020- B	SUPPORT ASSY, FR SEA T HEADREST	1			個数変更/Quantity Change 2個→1個		X		A
15										同左/No Change				
16		011	01		71930-48010- A	SUPPORT ASSY, FR SEA T HEADREST	1			使用追加/Additonal Adoption		N		X
17		012	01		71930-42020- B 71930-42020- B	SUPPORT ASSY, FR SEA T HEADREST	1			個数変更/Quantity Change 2個→1個		X		A
18										同左/No Change				

車種 383W
Model

設変切替依頼書 No.2

ENGINEERING CHANGE INSTRUCTIONS No.2

互換性 Interchangeability

旧PP 互NP
PP A:PVO NVO NP X:PVO NVO
PP B:PVO NVΔ NP Y123:
PP C:PVO NV× PVΔ NVO
PP D:PV× NV× NP Z:PV× NVO
C,Y,Z→Type Major

No

383WAF0150

Page

6 / 12

No.	工程 Routing (Process)	区分 Key	レベル Lvl	色 Color	旧品番 Previous Part No. 新品番 New Part No.	品名 Part Name	選択 個数 SI	Condi tion	認証 Regu 補給 Ser.	変更事項 Revision		出図Dwg. CAD	出図予定 出図コメント Dwg. Issue Dwg. Com	旧PP 互NP
										概要 Apply	共用先 Common			
1		012	01		71930-48010- A	SUPPORT ASSY, FR SEA T HEADREST	1					X		A
2												N		X
3														
4														
5														
6														
7														
8														
9														
10														
11														
12														
13														
14														
15														
16														
17														
18														

車種 383W
Model

設変切替依頼書 No.3

ENGINEERING CHANGE INSTRUCTIONS No.3

No.

383WAF0150

Page

7 / 12

No.	Group	Group Name	Vari/Bik Name	条 件 Condition	変更事項 Revision
1	7100AC	P-PB	3RD SIDE 2WAY & CTR H/R L EATHE	ALL ALL	構成部品変更/Component Part Change 同左/No Change
2	7100AC	P-NB	3RD SIDE 2WAY H/R LETHER	ALL ALL	構成部品変更/Component Part Change 同左/No Change
3	7100AC	P-PA	3RD SIDE 2WAY & CTR H/R F AB	ALL ALL	構成部品変更/Component Part Change 同左/No Change
4	7100AC	P-NA	3RD SIDE 2WAY H/R FAB	ALL ALL	構成部品変更/Component Part Change 同左/No Change
5					
6					
7					
8					
9					
10					
11					
12					
13					
14					
15					
16					

変更事項 (箇所・略図)

3RD MNL/PWR H/R ADJUSTER

① H/R STAY (SHAPE CHANGE)

71332-X7C03

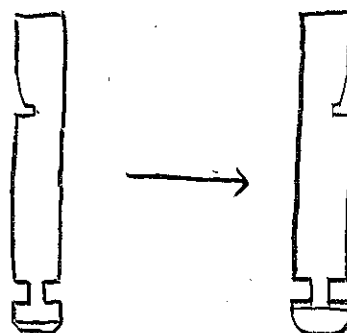
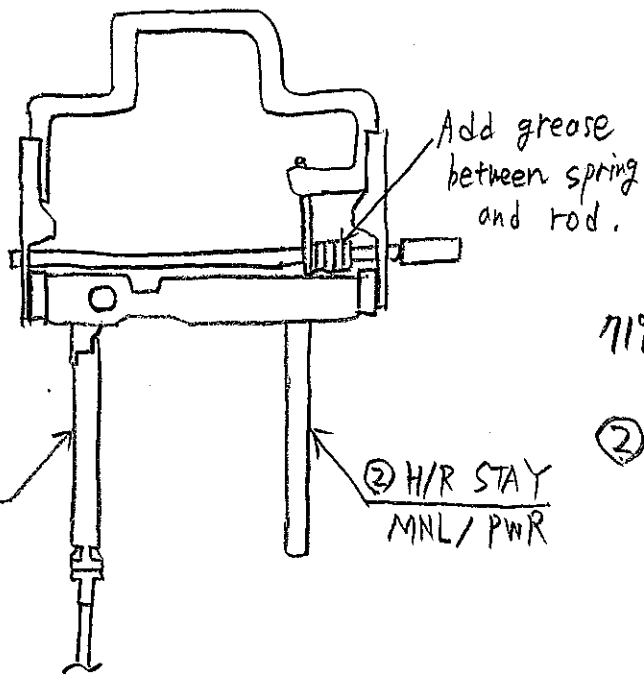

71941-X7C00-A 71941-X7C00-B

Total disuse due to
part list correction

② H/R STAY (SHAPE CHANGE)

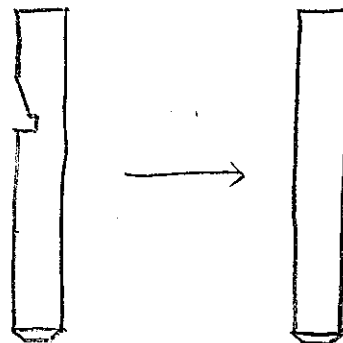

71941-X7C01 71941-X7C01-A

変更事項 (箇所・略図)

3RD MNL(PWR) BACK S/A 60%

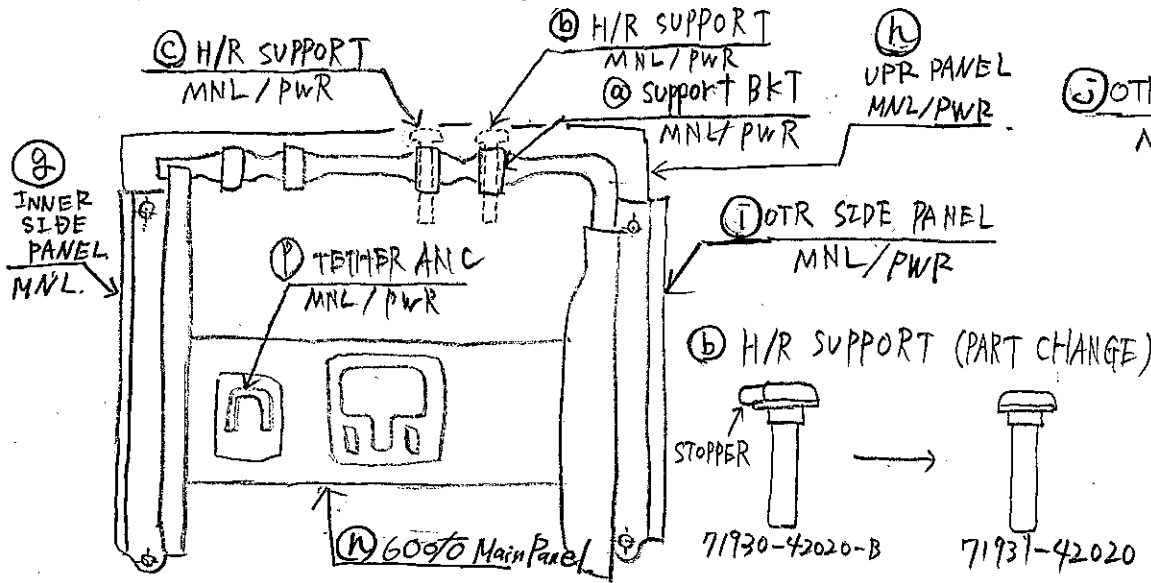

(a) Support BKT (PART CHANGE)

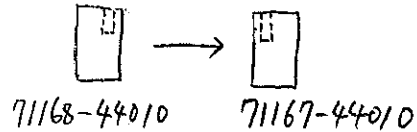

(c) H/R SUPPORT (PART CHANGE)

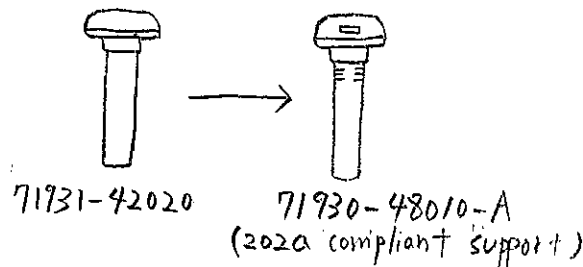

3RD MNL(PWR) BACK S/A 40%

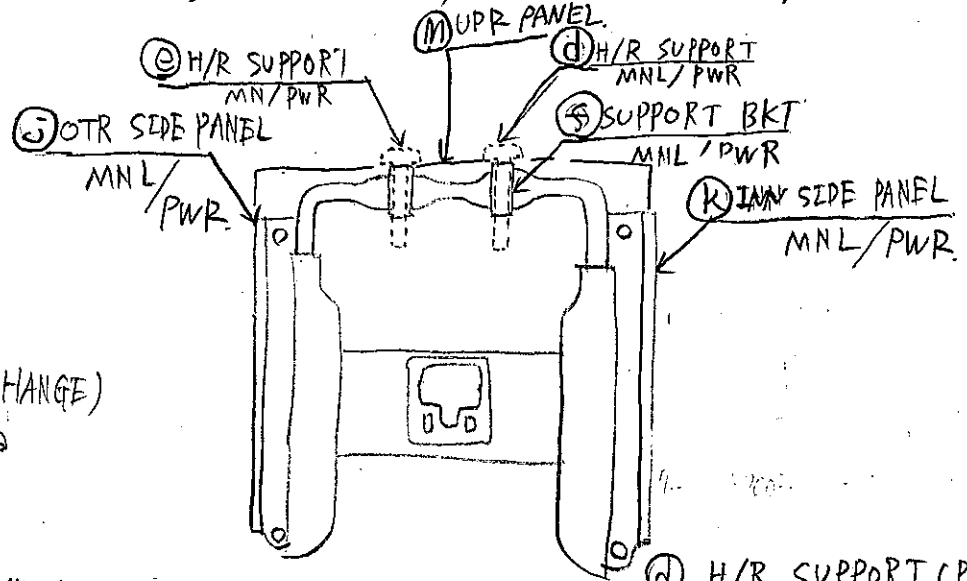

(s) Support BKT (PART CHANGE)

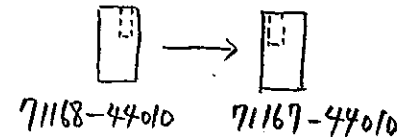

(d) H/R SUPPORT (PART CHANGE)

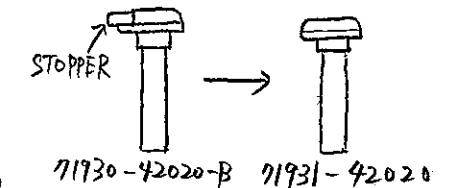

(c) H/R SUPPORT (PART CHANGE)

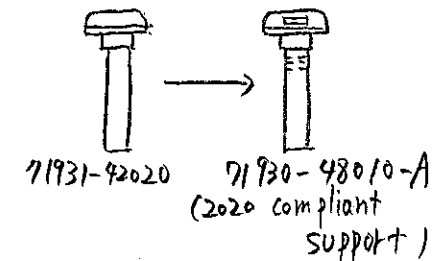

変更事項 (箇所・略図)

⑨ MNL, 60% INNER PANEL.

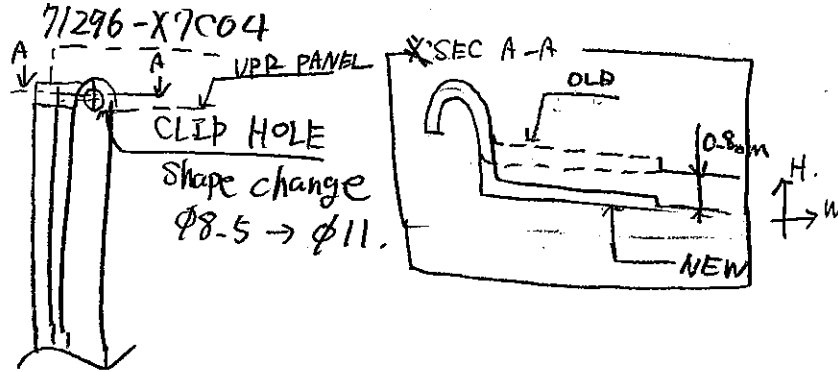

⑩ UPR PANEL, 60%,
MNL 71293-X7C02

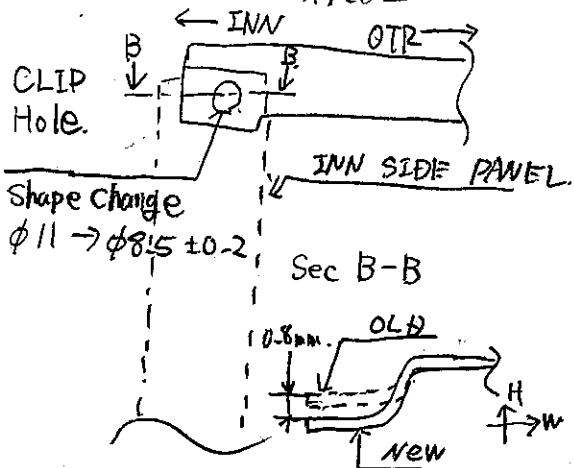

MNL 60% UPR PANEL
↳ OTR, No change

• PWR 71293-X7C03

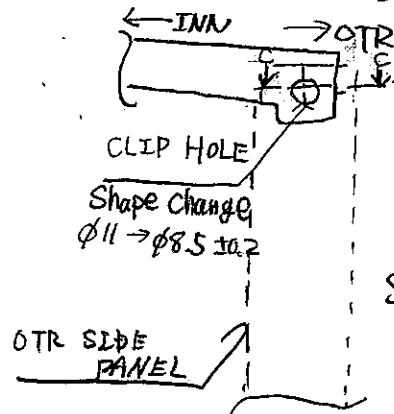

PWR 60% UPR PANEL
↳ INN, No change.

⑪ OTR PANEL 60% [PWR, MNL]

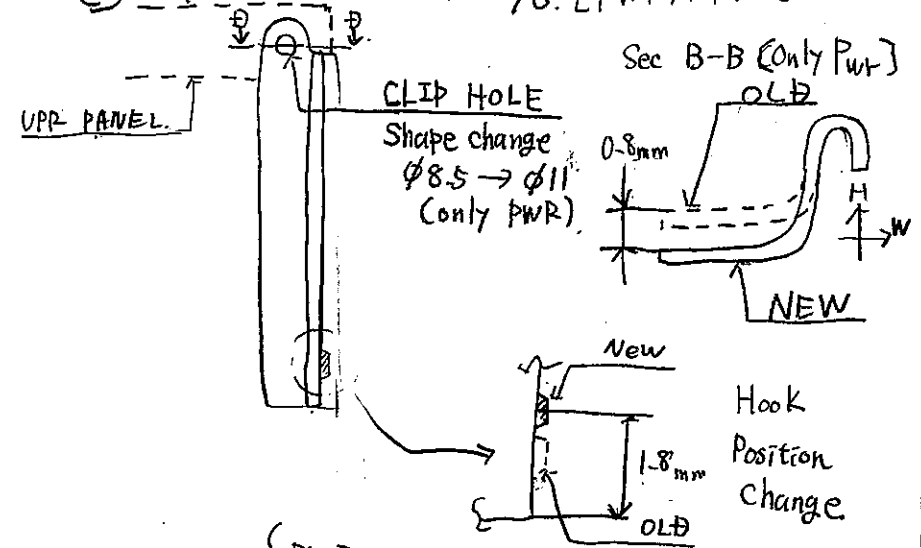

{ PWR OTR PANEL → 71296-X7C06
MNL OTR PANEL → 71296-X7C03

変更事項 (箇所・略図)

⑤ 40% OTR PANEL.

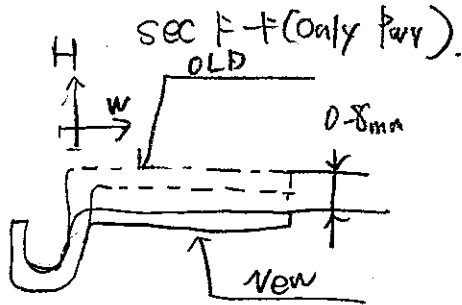
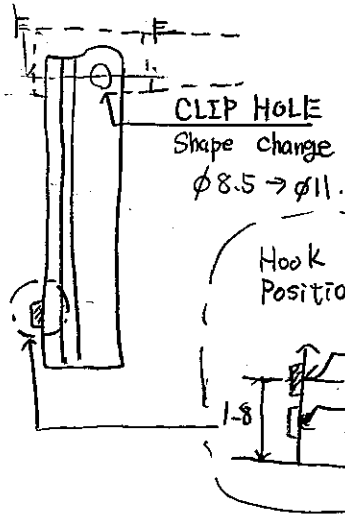

⑬ 40% UPR PANEL (PWR, MNL).

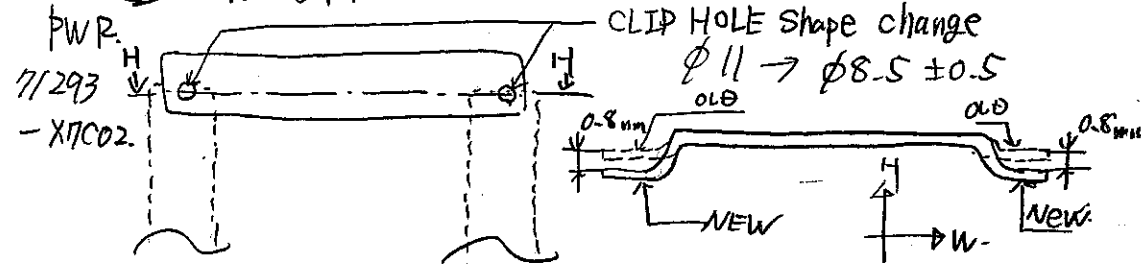

⑭ 40% INN PANEL (PWR, MNL).

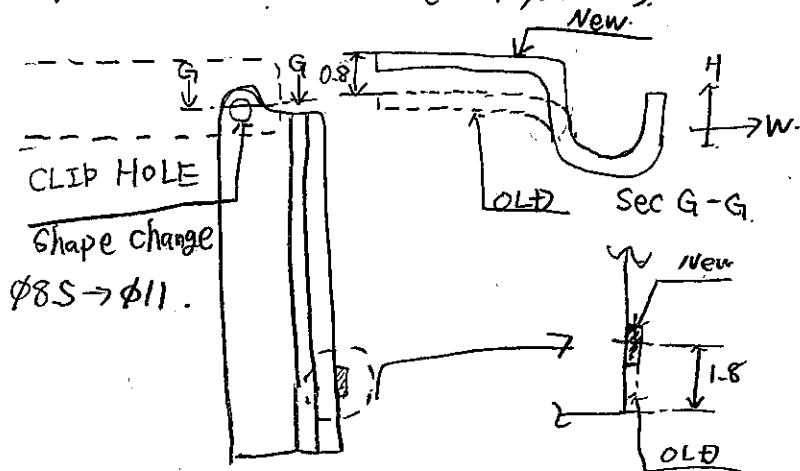

変更事項 (箇所・略図)

① 71273-X7C00-C

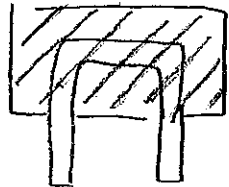

Add coating.

② TETHER ANC SHAPE CHANGE

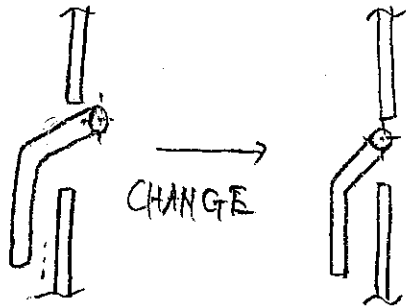

H/R ASSY (COMPONENT PART CHANGE)

◦ PAD SHAPE CHANGE (71097-0C050-A)

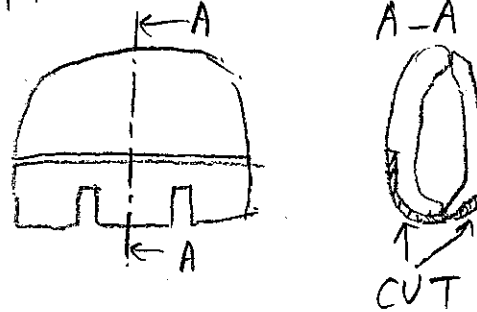

◦ COVER (71952-X7C01-A)

