

QUADRA-CHEK 2000

OPERATION
MANUAL

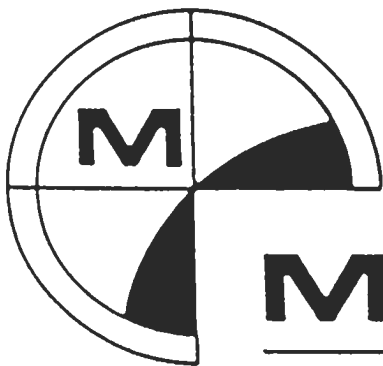

METRONICS

METRONICS, INCORPORATED
BEDFORD, NEW HAMPSHIRE, USA

SPECIFICATIONS

Input Voltage Range:	85 VAC to 264 VAC. 0.5 AMP MAX	<i>(Auto switchable)</i>
Input Frequency:	43Hz to 63Hz	
Fuse	1 AMP 250V TYPE T	

CAUTION - FOR CONTINUED PROTECTION AGAINST FIRE, REPLACE ONLY WITH FUSE OF THE SPECIFIED VOLTAGE AND CURRENT RATINGS.

Environmental Conditions:

Temperature:	0°C TO 45°C (32°F TO 113°F) non-condensing
Humidity:	90%rh
Altitude:	2000 meters
Pollution Degree:	2
Installation Category:	II
Dimensions	5.62 in (142.75mm) high, 10.75 in (273.05mm) deep, and 12.18 in (309.37) wide
Weight	Approximately 7 pounds
Output Signals	TTL Quadrature signal
Resolution	Any resolution down to .000004 inches, or .0001mm



The lightning flash with arrowhead symbol, within an equilateral triangle, is intended to alert the user to the presence of uninsulated “dangerous voltage” within the product’s enclosure that may be of sufficient magnitude to constitute a risk of electric shock to persons.



The exclamation point within an equilateral triangle is intended to alert the user to the presence of important operating and maintenance (servicing) instructions in the literature accompanying the system.

CAUTION: TO REDUCE THE RISK OF ELECTRIC SHOCK, DO NOT REMOVE COVER. NO USER-SERVICEABLE PARTS INSIDE. PLEASE REFER SERVICING TO QUALIFIED SERVICE PERSONNEL.

SAFETY AND MAINTENANCE PRECAUTIONS

1. Read all of these instructions.
2. Save these instructions for future use.
3. Unplug this product from the outlet before cleaning. The unit should be free of dirt, dust, and oil. Use a cloth dampened with any non abrasive cleaner for cleaning the exterior of the unit.
4. Do not place this product on an unstable surface. If the product should fall, it may become seriously damaged and more importantly, may cause injuries to the user. For Mounting instructions, refer to "Bolt Hole Mounting Pattern" in the Manual.
5. This product is equipped with a 3-wire grounding type plug, a plug having a third (grounding) pin. This plug will only fit into a grounding-type power outlet. This is a safety feature. If you are unable to insert the plug into the outlet, contact your electrician to replace your obsolete outlet. Do not defeat the purpose of the grounding-type plug.
6. Do not locate this product where the cord will be walked on.
7. The user should not attempt to service the Quadra-Chek. Opening or removing covers may expose you to dangerous voltage points or other risks. Customer support and service for all Quadra-Cheks are provided by a network of authorized METRONICS Dealers. Therefore, we ask that you contact your original dealer to request assistance.
8. Unplug this product from the wall and refer servicing to qualified service personnel especially under the following conditions:
 - a) When the power cord or plug is damaged or frayed.
 - b) If liquid is spilled into the product, or if the product has been exposed to rain or water.
 - c) If the product has been dropped or the exterior has been damaged.
 - d) If the product exhibits a distinct deterioration in performance, indicating a need for service.

IMPORTANT NOTICE

This device contains a battery which incorporates an automatic recharging design to maintain system settings during a power interruption.

As with any battery backed up device, memory corruption may occur if the battery is low and not recharged periodically.

If utilizing this device on a daily basis with the power left on, you will not encounter any memory loss problems due to low battery.

If however, the device is used only periodically or turned off when not in use it is recommended that the unit be left with the power on for one weekend per month to avoid any memory loss problems due to a low battery.

FCC Rule NP15R
Rev. 23 Jun. 89

IMPORTANT FCC NOTICE

This equipment has been tested and found to comply with the limits for a Class A digital device, pursuant to Part 15 of the FCC Rules. These limits are designed to provide reasonable protection against harmful interference when the equipment is operated in a commercial environment. This equipment generates, uses, and can radiate radio frequency energy and, if not installed and used in accordance with the instruction manual, may cause harmful interference to radio communications. Operation of this equipment in a residential area is likely to cause harmful interference in which case the user will be required to correct the interference at his own expense.

Shielded cables must be used with this unit to ensure compliance with Class A FCC limits.

This Class "A" digital apparatus meets all requirements of the Canadian Interference-Causing Equipment Regulations.

Cet appareil numérique de la classe "A" respecte toutes les exigences du Règlement sur le matériel brouilleur du Canada.

TABLE OF CONTENTS

SECTION	PAGE
I ESSENTIAL INFORMATION	1-1
QC-2000 Bolt Hole Mounting Pattern	1-3
Introduction.....	1-4
A Note To Dealers And Supervisors	1-4
A Note on Accuracy and Precision	1-5
Warning.....	1-5
About This Section	1-5
Other Sections.....	1-5
Conventions Used In This Manual	1-6
Getting Started	1-7
Getting Out Of Trouble.....	1-8
The QC-2000s Modes	1-9
Calibration Mode.....	1-8
Set Up Mode	1-8
Incremental/Absolute	1-8
Inch/Millimeter.....	1-8
Polar Mode/Cartesian	1-8
Edge/Crosshairs	1-9
Auto/Manual.....	1-9
Programming.....	1-9
Feature keys.....	1-9
Measuring With the QC-2000.....	1-10
Crosshairs	1-10
Targeting Points	1-11
What is a feature?	1-11
The feature list	1-11
Generating Features	1-12
Probing Features	1-12
Constructing Features.....	1-13
Creating Features	1-13
Getting Help	1-13
Continue Reading.....	1-14

TABLE OF CONTENTS

SECTION	PAGE
II DEMONSTRATION	2-1
Previous Reading	2-1
About This Section	2-1
The QC-2000 In One Easy Lesson	2-1
Getting Started	2-1
About Reference Marks	2-3
Axis Orientation	2-3
Reversing The Axis Count Direction.....	2-4
Axis Zero	2-5
Zeroing an axis.....	2-5
Targeting Points	2-6
Selecting The Edge Detector.....	2-6
Cross cal.....	2-6
Polar Mode	2-7
Skewing The Part	2-8
Forward - Backward Annotation	2-10
Point Measurement.....	2-12
Line Measurement.....	2-13
Circle Measurement	2-14
Distance Measurement.....	2-15
Changing Constructed Distances	2-17
Angle Measurement.....	2-18
To enable/disable the Vertex function:	2-18
To measure an Angle:.....	2-19
Constructions.....	2-21
Recall	2-22
Print all Features	2-22
To select Print all Features:.....	2-22
Using Measure Magic.....	2-23
Before you Begin	2-23
Using Measure Magic	2-23
Singular Mode Measure Magic	2-23
Auto Repeat Mode	2-24

TABLE OF CONTENTS

SECTION	PAGE
III USER PROGRAMS	3-1
Previous Reading	3-1
About This Section	3-1
About User Programs	3-1
Creating User Programs	3-1
Forward - Backward Annotation	3-2
Setting Backward Annotation	3-2
Debugging	3-3
Creating A Program.....	3-3
Editing User Programs	3-4
Special Program steps	3-5
Special Program Keys	3-5
Program Editing Keys.....	3-5
Executing User Programs	3-6
Running A Program	3-6
Deleting a User Program.....	3-7
When you wish to delete a user program use the following procedure.....	3-7
Sample User Programs	3-9
Advanced Techniques	3-11
Assigning Programs To Front Panel Keys.....	3-13

SECTION	PAGE
IV REFERENCE GUIDE	4-1
Previous Reading	4-1
About This Section	4-1
General Constructions Allowed	4-1
Constructing relationships	4-5
More	4-6
Cancel	4-7
Preset Operation	4-7
Preset Skew.....	4-9
Create Features.....	4-9
Multi-Point Measurements.....	4-10

TABLE OF CONTENTS

TITLE	PAGE
Measure Magic	4-13
Probing Techniques.....	4-13
Using Measure Magic	4-14
Singular Mode Measure Magic	4-14
Auto Repeat Mode	4-15
Skew On Two Circles Centers.....	4-15
Bolt Circle Calculation	4-16
Min/Max Radius function	4-17
Setup Menu	4-19
Edit Cal.....	4-23
Error Messages	4-24
Incorrect Key.....	4-24
No Construction	4-24
Out Of Range.....	4-24
No More Pts	4-24
Program Locked.....	4-24
Wait RS-232 Port.....	4-24
No Intersection.....	4-24
Axis Blinking	4-24
Reference Glossary.....	4-25

SECTION	PAGE
V COMMUNICATION SECTION	5-1
Set Up.....	5-2
Feature Print Formats.....	5-3
Feature Format.....	5-4
Assigning A Custom Header.....	5-5
Print All Features.....	5-5
Input Codes	5-13
RS-232 Commands	5-13

TABLE OF CONTENTS

SECTION	PAGE
VI SUPERVISOR SETUP	6-1
Supervisor Set Up	6-1
Entering Supervisor Set Up	6-2
Auto Setup	6-3
Tablet Yes/No	6-5
Encoder Resolution	6-5
Reference Marks	6-6
Corrections	6-7
Slec	6-7
To Acquire Your Calibration Points:	6-7
How To Determine A Segment	6-8
Making A Graph	6-8
Graphing The Segments	6-9
Setting Up Slec	6-10
Linear Error Compensation	6-11
Non-Linear Error Compensation	6-12
Locking User Programs	6-13
Prescale	6-13
Q Axis Type	6-14
Keep Features	6-14
Brightness	6-14
Vertex	6-15
Relations	6-16
Reference Marks	6-17
Reference Mark Calibration	6-17

SECTION	PAGE
VII OPTIONS	7-1
Option Summary	7-1
Keypad and FootSwitch	7-2
Remote Keypad Test	7-4
Electronic Protractor	7-4
A Note on Theory	7-7
NLEC Setup	7-9

TABLE OF CONTENTS

TITLE	PAGE
Edit NLEC Station Errors.....	7-10
Print NLEC Report.....	7-10
QC2000 Smart Eye Input.....	7-11
Edge Detector Installation	7-12
What Is Edge Detection?.....	7-12
How Edge Detection Works.....	7-12
The Sensors	7-12
Connecting Sensors to the QC-2205.....	7-13
Connecting the Screen Sensor to the Comparator.....	7-13
Connecting the Reference Sensor to the Comparator.....	7-13
Cautions About Fiber Optic Cables	7-13
Placing the Reference Sensor Outside the Lamp Housing	7-14
Placing the Reference Sensor Inside The Lamp Housing	7-14
Checking the Sensors (install).....	7-14
The Screen Sensor	7-15
The reference sensor	7-15
Calibration	7-15
Edge Detector Operation.....	7-16
About Edge Detection.....	7-16
How Edge Detection Works.....	7-17
Selecting The Edge Detector.....	7-17
Auto Mode	7-17
Auto Cal.....	7-18
Distance Cal	7-18
Cross Cal.....	7-20
Install.....	7-20

SECTION	PAGE
VIII QC-2000 MENU	8-1

QUADRA-CHEK 2000

SECTION I ESSENTIAL INFORMATION

Essential Information

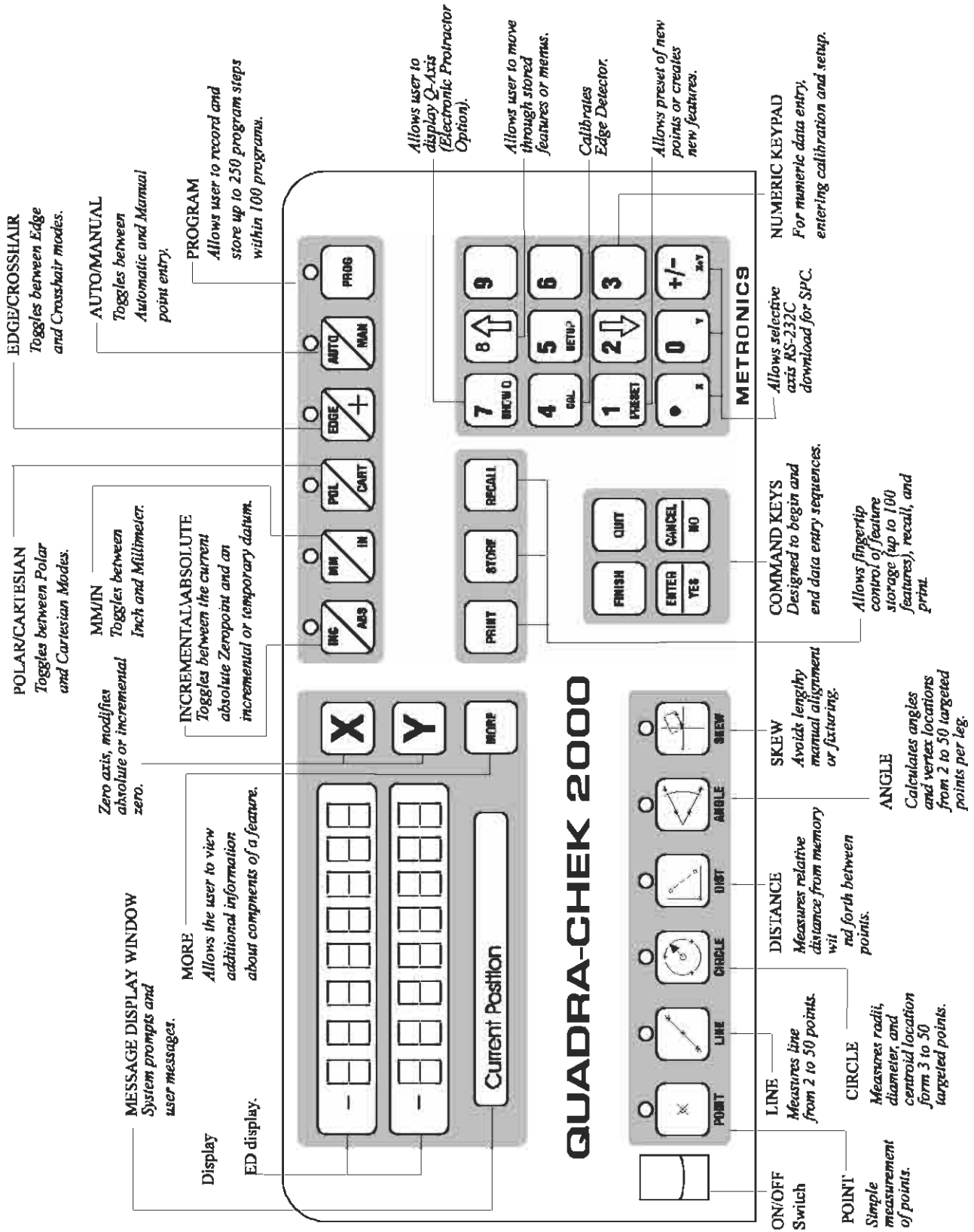

Essential Information

Title: 2CSABK.EPS from CorelDRAW!
Creator: CorelDRAW!
CreationDate: Wed Jan 11 15:43:06 199

BOLT HOLE MOUNTING PATTERN

Drill four (4) .140 diameter holes (#28 drill) dimensioned as shown in the following illustration. These holes are in the same position as the four (4) pem nuts located on the bottom of the system chassis. Use four (4) 6-32 screws to secure the unit in the desired location on the mounting frame.

CAUTION

Do Not use screws that will extend more than 3/4" into the unit because the possibility of electrical shock exists

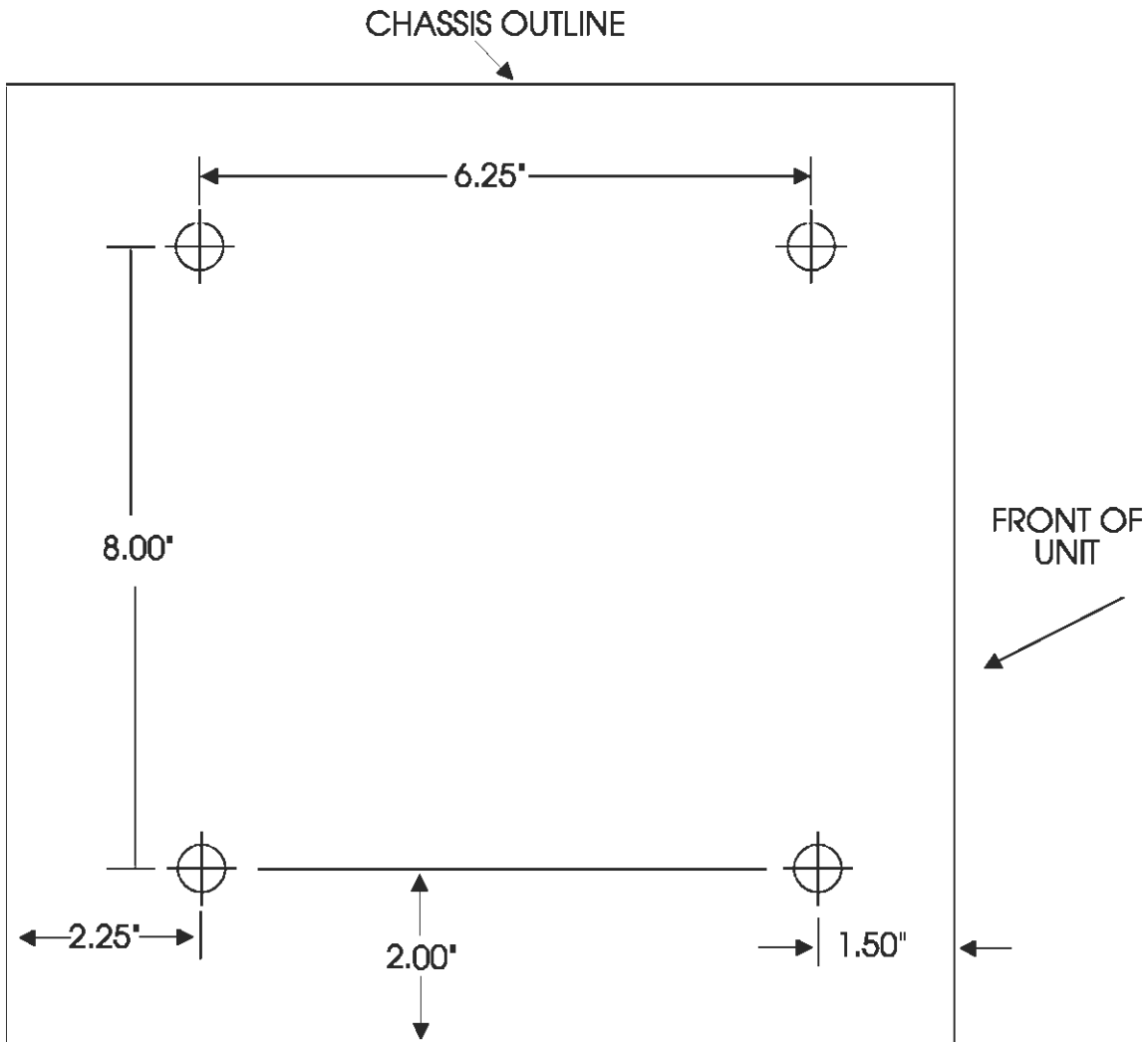

INTRODUCTION

This manual is divided into several sections. The Information Section is the first section you should read. It provides all the information needed to understand the Demonstration and Reference Sections.

If you are an advanced user of digital readouts, some of the information contained in this manual will come as no surprise. Feel free to skim, but please do not skip the reading entirely.

The QC-2000 series digital readout is manufactured in several versions. The terms QC-2000, 2000 or system when used in this manual refers to the QC-2000 general product line. The following table is included in the manual at this point for your convenience.

QC-2000 SERIES

	<u>2 Axis</u>	<u>Optical Edge Detector</u>	<u>Electronic Protractor</u>
QC-2200	X		
QC-2203	X	X(* Optional)	
QC-2205	X	X	
QC-2210	X		X
QC-2213	X	X(* Optional)	X
QC-2215	X	X	X

* Accepts input from other edge detection units.

A NOTE TO DEALERS AND SUPERVISORS

Metronics, Inc. assumes that all Metronics QC-2000s will be set up for end-users by the dealer. This set up includes calibration according to the user's optical comparator or similar device, and installation of Non-Linear Error Compensation (optional) on the user's comparator.

If the end-user installs a new comparator, then it may become necessary to do everything all over again. In that case, supervisory personnel may want to refer to the Set Up and NLEC sections of this manual. Otherwise, they should contact their original dealer or, failing that, Metronics, Inc.

A NOTE ON ACCURACY AND PRECISION

The QC-2000 is an instrument capable of great accuracy and precision. You may find that the accuracy of the machine's human operators is less than the accuracy the machine is capable of. You may also find that the machine displays measurements to more significant figures than you need. Metronics, Inc. is aware of these discrepancies, but the QC-2000 is designed for those applications where great accuracy and precision are required.

Also, the accuracy of the encoders attached to your comparator is physically limited, as is the accuracy of the QC-2000's Edge Detector. All things considered, the QC-2000's Edge Detector is repeatable to within ± 1 micron. Therefore, a QC-2000 attached to 1 micron encoders is repeatable to at least ± 2 microns.

WARNING

There is NEVER any need to open the QC-2000, since there are no user-serviceable parts inside. As with any similar device, the danger of electrical shock exists if the top is removed. Please refer all maintenance to your original dealer, or failing that, Metronics Inc.

ABOUT THIS SECTION

This section provides the information necessary to operate the QC-2000 Digital Readout System to its fullest potential. Although the QC-2000 is easy to operate, reading this section will save you much aggravation.

OTHER SECTIONS

This manual is written to cover the basic QC-2000. Information about the options (additional, available features) is provided in the Option Section of this manual. The manual is divided into five main sections, which are intended to aid you in using the manual and the QC-2000 Digital Readout System.

The Demonstration Section is designed to give you a working knowledge of the QC-2000 and provides complete instructions for measuring the sample part included with this manual.

Please read Reference Section of this manual to gain a more detailed understanding of the QC-2000. The Reference Guide gives a detailed description of all the QC-2000's functions, as well as hints to help you get the most out of your Quadra-Chek.

CONVENTIONS USED IN THIS MANUAL

The terms QC-2000, 2000 or system when used in this manual refers to the QC-2000 general product line. This manual uses the term comparator to refer to any device intended to measure parts in two dimensions. Through out the manual we refer to the targeting portion of measuring machines as crosshairs.

It is assumed for all demonstrations that if you move your crosshairs to the right the count increases from 1 to 2 to 3, not from -1 to -2 to -3. The same holds true for the Y axis: If you move the crosshairs up the count increases from 1 to 2 to 3. If you find that your machine is not reading properly, don't worry. The examples in this manual will tell you how to adjust the count direction to match this convention.

For most examples, the display resolution in this manual will be one ten-thousandths of an inch (**0.0001**) or two microns metric (**0.002**). Please note that your QC-2000 may be set to a different resolution, but don't let this concern you. You don't need to change the display resolution, simply follow the logic of the examples presented.

In the graphic examples, the "ON" LED condition is represented by a light circle above the key as shown below on the left. An "OFF" condition is represented by a darkened circle.

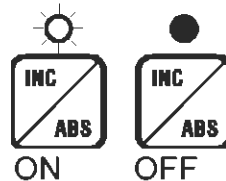

In the illustrations, there may be "optional" keypresses shown. If the indicator light above the key on the QC-2000 is already in the state shown in the illustration, you won't need to press that key.

The terms Program Steps and Key Presses mean the same, a single line item in a User Program.

A program is a series or sequence of Key Presses that make up a procedure used to perform a measurement activity.



b.

When you see a picture of a key with a letter underneath it (as shown here), you should press that key when you come to that step in the demonstration. For this example you would press the ENTER key when you reach step b. of the instructions.

Essential Information

When three periods are observed at the end of a prompt in the message window (e.g. Record program?...) it indicates additional information may be viewed by pressing the MORE key

All menu items followed by a YES or NO may be changed by pressing the desired key i.e., press the NO key to change "POE YES" to "POE NO."

GETTING STARTED

We assume that your QC-2000 has been set up and is ready for you to turn on.

The QC-2000's power switch (labeled 0 and 1) is located in the lower left corner of the front panel, to the left of the feature key row. Turn the QC-2000 "On".

The axes windows labeled X and Y and the message window are your primary sources of information while you are using the QC-2000. The numbers you see in the X and Y axes windows are the QC-2000's Digital Read Out (DRO). Move the crosshairs slightly and watch the displayed numbers change.

GETTING OUT OF TROUBLE

In most cases, except for programming, pressing the **QUIT** key twice will cancel what you have been doing and bring you back to the DRO. As a last resort, you can turn off the QC-2000, wait 5 seconds, and turn it back on.

THE QC-2000S MODES

The Quadra-Chek 2000 has several different operating modes, all of which fall into one of three main groups, Targeting Modes, Display Modes and Configuration Modes.

Targeting Modes define how data points must be entered for the QC-2000 to accept them. Display Modes define how that data is displayed. Configuration Modes tell the QC-2000 how to interpret the data it receives from your comparator.

These modes are described here in order to prepare you for the examples in the remainder of the manual. Please refer to these pages if "Mode Madness" starts to get to you.

Configuration Modes

Calibration Mode

The Calibration Mode is where you set up the edge detector so the QC-2000 can sense edge crossings. The QC-2000 will calculate how far apart the edge detector is from the crosshairs so you can switch between the two targeting modes and still target points accurately. Refer to the Supervisor's setup Section of the manual.

Set Up Mode

Here you match the QC-2000 to the signal output of the comparator the QC-2000 is used with. These changes are made in the Set Up Mode which is described in the Supervisor's SetUp Section.

MODE KEYS

The Mode keys are located at the upper right corner of the front panel. These pairs of mode keys *are not* mutually exclusive, however, the items within the pairs *are* mutually exclusive. Descriptions of where the QC-2000 displays this mode information is given in the QC-2000's Front Panel paragraph.

DISPLAY MODES

Incremental/Absolute

Remember that the QC-2000 has 2 datum's. When the light is "ON," the distances displayed are measured from the incremental datum (0,0 point) and all measurements are relative to that datum. When the light is "OFF," the distances are measured from the absolute datum.

Inch/Millimeter

When the MM/IN light is "ON," all measurements displayed are in millimeters. When the light is "OFF," all measurements are displayed in inches.

Polar Mode/Cartesian

When the light above the POL/CART is "OFF," the QC-2000 is in Cartesian Mode. All distances are displayed as an axis pair (x, y) where 'x' is the horizontal distance from the current datum and 'y' is the vertical distance.

Note that the current datum is either the incremental datum or the absolute datum depending upon the state of the INC/ABS light.

When the light is "ON," the QC-2000 is in Polar Mode. All distances are measured from the current datum and are displayed in that form (r, a). See the Reference Section for a discussion of Polar Coordinates.

TARGETING MODES

Edge/Crosshairs

If the EDGE/+ light is "ON" and the AUTO light is "OFF," the QC-22X5 is in Edge Mode (these keys are only active with the 22X5). In this mode, the display is updated and a "beep" is generated after every edge crossing. An edge crossing occurs when the light sensor crosses from a light area to a dark area, or from dark to light. This mode facilitates easy targeting of points that lie on shadow boundaries.

To target and enter a point along an edge, cross the edge, and press ENTER. For best results, try to cross the edge perpendicularly. That is, cross the edge "straight on."

If the light above the EDGE/+ key is off, the QC-2000 is in Crosshairs Mode. In this mode, the display is updated continuously, and the crosshairs are the targeting mechanism. To target and enter a point in this mode, place your crosshairs over the point to be entered and press ENTER.

Auto/Manual

If the light above the AUTO/MAN key is "ON," the QC-2205 is in Auto Edge Mode (this key is only active with the 22X5). This mode is the same as Edge Mode, except that each edge crossing is automatically accepted and entered without confirmation for faster point entry.

When the light is "OFF" the QC-2000 is in the Edge Mode and/or the Manual Mode. The Manual Mode is used for point entry, where every point must be confirmed with a manually entered keypress.

Programming

When the light above PROG is "ON," the QC-2000 is activated for one of the three types of programming functions: Executing, Recording, or Editing. Refer to the Programming Section.

FEATURE KEYS

The QC-2000's front panel has six function keys located in the lower left corner. These are called Feature Measure Keys.

Pressing these keys; POINT, LINE, CIRCLE, DIST and ANGLE will initiate its respective feature measurement, i.e., pressing the CIRCLE key will start the procedure for measuring or constructing a circle. The SKEW key is used to align a part with respect to the comparator's bed to provide accurate measurements. The first step performed when measuring a part should be to skew the part

MEASURING WITH THE QC-2000

The QC-2000 greatly simplifies the use of an optical comparator to perform precise, repeatable measurements. The QC-2000 is capable of a wide variety of measurements: points, lines, circles and other geometric shapes. *The QC-2000's strong point is not just what it can do, but the ease with which it can do it.*

With the QC-2000, you always measure distances from a given datum point, which is known as the Absolute Datum (or origin). It has coordinates 0, 0. The QC-2000 allows you to set the Absolute Datum to any physical point on or off the part you are inspecting. Additionally the QC-2000 allows you to set the orientation of the X and Y axes -- they do not have to be parallel with your comparator's axis.

Once you have established the Absolute Datum and the orientation of the axes, you have defined a Reference Frame. This Absolute Datum allows you to set a zero reference point from which to measure additional points, and set an Incremental Datum from which you can make intermediate measurements.

The QC-2000 will perform complex geometric and algebraic calculations for you at the touch of a few buttons. For example, you can calculate the position of a circle's center and find its radius by giving a few points on the circle's edge. Or, you can calculate what angle two legs of a part make with each other, again by giving the QC-2000 a few points.

When you need to measure a particular point (instead of just any point that lies on a boundary), you will need to target that point with crosshairs.

Edge detection is well-suited for making measurements where any point on a shadow boundary is as valid as any other on that boundary. The QC-2000's optional Edge Detector senses changes in the brightness of a location on your comparator's screen, so the QC-2000 knows when you have crossed a shadow boundary.

CROSSHAIRS

The QC-2000 allows you to switch back and forth between either the crosshairs or the edge detector (providing you have the edge detector option). In order to do this, the QC-2000 (22X5) must know how far apart the edge detector's screen sensor and the crosshairs are. Refer to the Crosshairs paragraph in the Demonstration Section. *This calibration must be done every time you move the edge detector's screen sensor or change magnification.*

TARGETING POINTS

You are almost ready to jump over to *The QC-2000 Demonstration*, but first you must know how to target a point.

“Targeting a point” is the process of telling the QC-2000 that you wish to include a particular point in the current measurement calculation. You may target a maximum of 50 points for each feature except a distance.

In the Demonstration Section of this manual you will be targeting points using either the edge detector (in the Auto Mode) or crosshair. When the system is in Auto Edge Mode configuration you only need to cross an edge on the part you are measuring and you will hear a “beep” and see a point has been entered.

If you are using crosshair on a comparator with a video probe or a microscope, align the crosshairs on the feature you are measuring (e.g., the circumference of the circle you are entering) and press ENTER.

WHAT IS A FEATURE?

The geometric entities that you generate with a QC-2000 include points, lines, circles. Each time you complete one of these elements, you have created a *feature*. This feature is then placed at the bottom of the Feature List. Each feature has different distinguishing information. For instance, circles have a center and radius, points have a location and angles (which are relations) have a degree reading. A *relation* is the result of a construction involving two features (angles and distances are a special subset of features called relations).

THE FEATURE LIST

When a new feature is generated, a mathematical representation is placed in the feature list. Later you will learn how to single out features in the feature list that you wish to make permanent. Permanent features are retained when the QC-2000 turned off.

The QC-2000 stores 100 Permanent Features plus the 9 most recent Temporary Features. (Temporary Features are retained when the QC-2000 is shut off.) When you create the 10th feature, the oldest Temporary Feature is “pushed” off the stack.

The feature list consists of two stacked lists. The temporary features, “a1” through “a9,” on the bottom and the permanent features, “00” up through “99”, stacked on top of the temporary features. Permanent features are created by selecting a temporary feature (viewing it in the message window) and pressing the **STORE** key. Permanent features are overwritten when the stack is full and a new feature is added. See Figure 1-1. Refer to the paragraph on the STORE and RECALL keys in the *Reference Guide*.

Essential Information

"Pushing Features" refers to the process of adding a feature to the temporary list and moving the other features up to make room for the new one. When a new feature is added, it is inserted at the bottom of the list becoming "a1" and pushes the existing features up one ("a1" becomes "a2," "a2" becomes "a3" etc.). If a feature is at "a9" and is pushed, the feature is deleted from the list.

"99"	XXXXXXXXXX	Permanent Features
-----	-----	
-----	-----	
-----	-----	
"12"	XXXXXXXXXX	
"11"	XXXXXXXXXX	
"10"	XXXXXXXXXX	
"09"	XXXXXXXXXX	
-----	-----	
"04"	XXXXXXXXXX	
"03"	XXXXXXXXXX	
"02"	XXXXXXXXXX	
"01"	XXXXXXXXXX	
"00"	XXXXXXXXXX	
-----	-----	
"a9"	XXXXXXXXXX	Temporary Features
-----	-----	
"a4"	XXXXXXXXXX	
"a3"	XXXXXXXXXX	
"a2"	XXXXXXXXXX	
"a1"	XXXXXXXXXX	

Figure 1-1. Temporary/Permanent Feature List Stacking.

GENERATING FEATURES

Now that you have been exposed to what features are and where they are used, each generation procedure will be described briefly to familiarize you with the different methods. Feature generation methods are further expanded upon in Section II, Demonstration.

Probing Features

One way to generate features, probably the method you'll use the most, is to probe the feature using the crosshairs to target the point to be entered and pressing **ENTER**. To probe a feature with the Edge Detector, first select the Feature Type you wish to measure. Cross the edge at the appropriate point of the feature and the QC-2000 will beep to show you that you have entered a point.

Each feature can be defined by as many as 50 probed points, with each point contributing to the final feature.

Essential Information

When you have entered the number of points you want, press FINISH. This tells the QC-2000 to calculate the resulting feature. This feature is automatically placed at the bottom of the Feature List.

Forward Annotation is the process of designating a specific number of points for the targeting of a feature. When that number of points is reached, the user program automatically advances the system to the next program step.

Backward Annotation is the process where the program does not indicate a pre-determined number of points targeting a feature. When the program reaches the targeting step it waits for operator input to advance the system. When the operator has determined that a sufficient number of points, (2 to 50) has been targeted he presses the appropriate key.

Constructing Features

Constructing features consists of taking previously generated features, grouping them together, and making a new feature. For example, if you have probed two circles the QC-2000 can construct a line that passes through the centers of both circles. The result will be the same as if you had targeted those circle centers while probing a line.

The QC-2000 can also take several circles and calculate the circle that comes closest to passing through those five circles' centers. This example is commonly called a Bolt Hole Circle.

Creating Features

The third way to generate features is to create them. You tell the QC-2000 that you want a circle with its center at absolute part coordinates (5, 6) and a radius of 10. This is done by entering the desired numbers in the appropriate fields of the feature.

One final note: You cannot partially probe and then partially construct a feature or relation. You must completely probe or completely construct a feature or relation.

GETTING HELP

Even though the QC-2000 can perform complex operations, it is fairly easy to use. However, should you need help, don't forget to use the manual.

This *Essential Information* section starts you off with the QC-2000, and covers everything from the necessary vocabulary to some theory about the QC-2000.

The *QC-2000 Demonstration* is designed to let you actually use the QC-2000, and presents the basic measurement and relational capabilities of the QC-2000.

Essential Information

The *User Programming* section provides you with the information needed to develop and utilize your own programs. There are even some sample programs at the end of the section.

The *Reference Guide* gives an in-depth view of all the QC-2000's functions, especially those not covered in this section or the *Demonstration* section. Also included in the *Reference Guide* is the Glossary, an invaluable aid to reading all the documents in this binder.

The *Communications Section* gives important information about the RS-232 Port. It is here that you will find a wiring diagram for making your own cables, as well as how to set up your QC-2000 for communication to an IBM compatible computer or an Epson compatible printer. You will also see samples of 32, 40 and 80 column printouts.

Supervisor Set Up provides the information needed to connect a QC-2000 to a wide variety of measuring machines. If your QC-2000 is already connected and functioning properly, you have no need to read *Supervisor Set Up*.

Options If you purchased optional equipment for the QC-2000 such as a Remote Keypad, Footswitch or Electronic Protractor you will find the documentation located in the Options Section.

CONTINUE READING

This concludes the Essential Information section of this manual. Please continue reading *The QC-2000 Demonstration*, found in the following section of this manual. There you will also cover the sample part included with your QC-2000.

QUADRA-CHEK 2000

SECTION II DEMONSTRATION

PREVIOUS READING

Before reading this section, you should have read *Essential Information*. It gives you good background information for the material covered in this section.

ABOUT THIS SECTION

This section will lead you through the most used operations of the QC-2000 Digital Readout System. When you are familiarizing yourself with this manual you may use a QC-2200, QC-2203, or QC-2205 Digital Readout System with Edge Detection.

We will assume that you will be operating in the Backward Annotation Mode. The difference between Forward Annotation and Backward Annotation is, that in Forward Annotation, the number of points is determined prior to beginning the measurement. The points in the display will decrement until the required number of points is reached. At that time the feature will be calculated. In Backward Annotation, the operator may enter up to 50 points for a measurement but must press FINISH after the required number of points is entered.

THE QC-2000 IN ONE EASY LESSON

Included with your QC-2000 is a Quickie Slide. All the instructions that follow refer to that slide. Begin the lesson by turning on your comparator and the QC-2000. The opening message screen contains information such as the part number, QC-2000; the copyright date, 1989 by Metronics Inc.; and the software version. Press any key on the QC-2000's front panel to move past the opening message. The X and Y Axis Windows now contain zeros and the message window reads "Current Position." The LED above the POLAR/CART key is out, indicating the DRO is in the Polar mode. The LED above the INCH/MM key is out, indicating that the system is the inch mode.

GETTING STARTED

Place the demonstration slide on your comparator (See Figure 2-1). Perform each step of this demonstration in the order that it is presented. Feel free to repeat any section until you are comfortable with the concepts and the methods used.

Demonstration

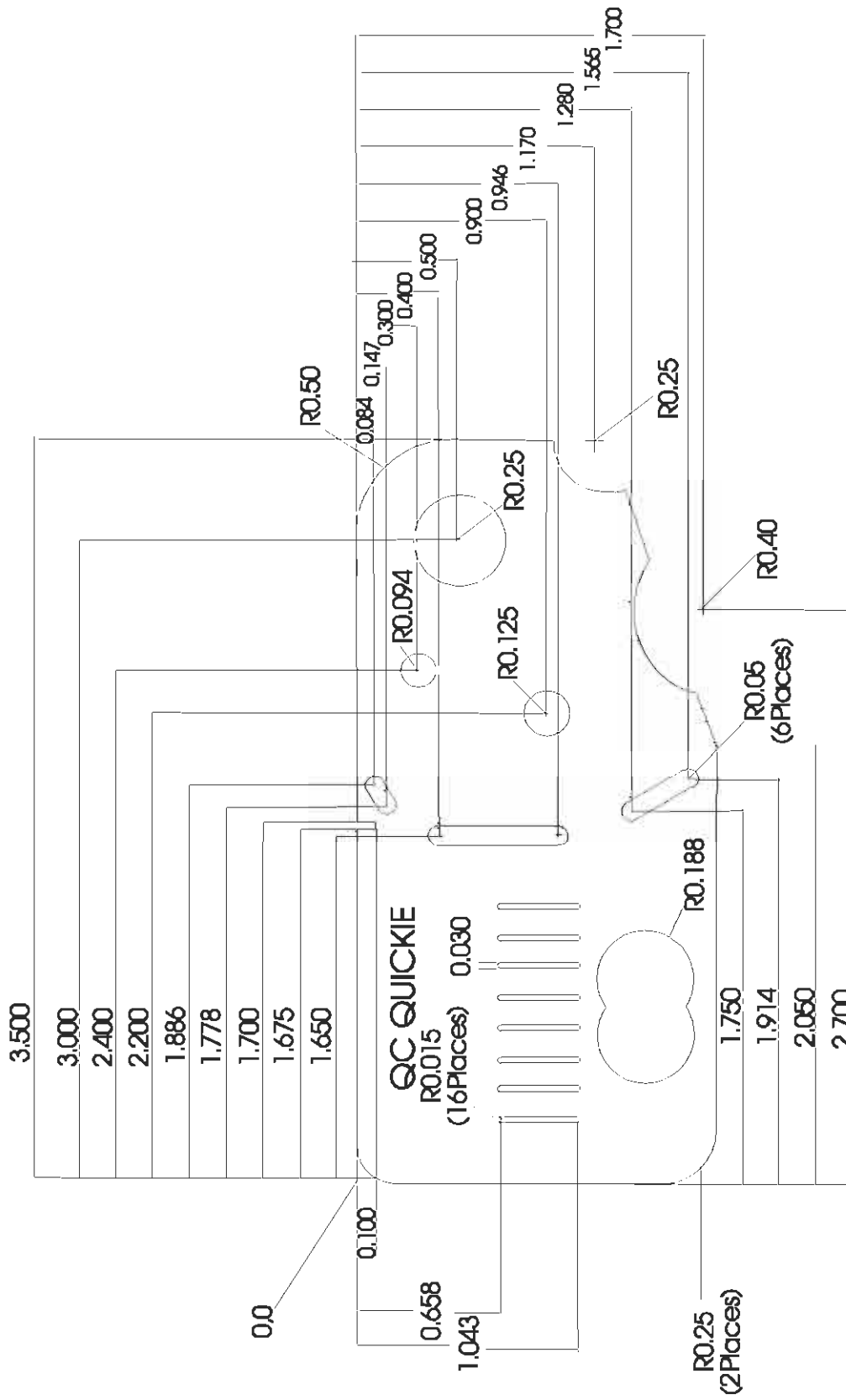

Figure 2-1. Quickie Demonstration Slide.

ABOUT REFERENCE MARKS

If your QC-2000 has the Reference Mark indicator enabled, the first thing you must do is calibrate your reference marks on your linear encoders. Please read the following information to help you understand how this feature works. If you do not have the Reference Mark indicators, you may skip this section and proceed to Axis Orientation.

When using the Reference Marks on Linear Encoders, some control is necessary to maintain a repeatable machine reference. Some DRO's will only sense this mark when moving in a certain direction. This *pre-determined* direction may not yield the optimal performance in a given application.

Since some reference marks have a certain thickness, referencing from left to right may give a different result than referencing from right to left. If you reference your linear encoders in either direction you will need to perform a Reference Mark Calibration. Calibrating will teach the QC-2000 the width of the Reference mark, so that it may compensate for that width no matter which direction you reference from.

Reference Mark Calibration is located under the Supervisor Setup menu. This calibration should be performed the first time you turn on the QC-2000 before any other setup function are done.

Once this procedure is performed, cycle the power. Remember this calibration need only to be performed one time. Your dealer may have already performed this for you. If not, please refer to the Supervisor Setup section of this manual to learn how to calibrate you reference marks.

AXIS ORIENTATION

The QC-2000 must be set up for the proper axis orientation. For the purpose of this demonstration, we assume that if you move the crosshairs to the right, the X count increases from 1 to 2 to 3 and not from -1 to -2 to -3. The same holds true for the Y axis. If you move the crosshairs up the count increases from 1 to 2 to 3.

Move the crosshair to the right. The number in the X display should increase. If the number does not, the X axis needs to be reversed.

Test the Y axis by moving the crosshair up. The number in the Y display should increase; if it decreases the Y axis needs to be reversed.

If you find that neither axes need to be reversed, skip the paragraph about Reversing The Axes Direction and continue with Targeting Points.

REVERSING THE AXIS COUNT DIRECTION

If you find that one or both axes are reading backwards, perform the following steps:



Enter Setup?

a.



Clear

b.



Axis Direction

c.



Reverse X No

d.



Reverse X Yes

e.



Reverse Y No

f.



Reverse Y Yes

g.



Reverse Q No

h.



Reverse Q Yes

i.



AXIS DIRECTION

j.



Current Position

k.

- a. Press the **5/SETUP** key on the QC-2000's Numeric Keypad.
"Enter Setup?" appears in the message window.
- b. Press **ENTER**.
"Clear" appears in the message window.
- c. Press the **DOWN ARROW** until "Axis Direction" appears in the message window.
- d. Press **ENTER** to bring up the sub menu.
"Reverse X No" appears in the message window.
- e. Press **ENTER** to reverse the axis (if the X Axis needs to be changed).
- f. Press the **DOWN ARROW**.
"Reverse Y No" appears in the message window.
- g. Press **YES** to reverse the axis (if the Y Axis needs to be changed).
- h. Press the **DOWN ARROW**.
"Reverse Q No" appears in the message window.
- i. Press **YES** to reverse the axis (if the Q Axis needs to be changed).
- j. Press **FINISH**.
"AXIS DIRECTION" appears in the message window.
- k. Press **FINISH** a second time to exit the Setup Menu.
"Current Position" appears in the message window.

Repeat the axis orientation procedure located on a previous page to verify that the axes are reading correctly.

AXIS ZERO

The QC-2000 lets you select the origin points for both incremental and absolute measurements. Absolute measurement is the distance from a fixed starting point on the part and a second point to which you move. (0, 0 or origin is the fixed point from which all distances are measured) Incremental measurement refers to a distance that is not measured with reference to a fixed origin. Instead, the distance is measured between the previous point and some new point. For example, if you move the crosshairs 5 inches in the positive X direction (to the right) from the 0, 0 origin, the absolute measurement is five and so is the incremental distance. Suppose you zero the incremental datum and move an additional 5 inches in the same direction. Incrementally you have moved another 5 inches; For the absolute distance from the point of origin to the present location is 10 inches (5+5=10), not 5 as with the incremental.

The QC-2000 has two datum points, absolute and incremental, which operate simultaneously. For this example, both datum points must be zeroed before you begin. Zero the absolute datum first then zero the incremental datum. When the absolute zero is set the incremental zero is set to the same location as the absolute zero.

To zero the absolute datum, first make sure that you are in Crosshairs Mode. Then center the comparator's crosshairs over the point to become the origin and proceed as follows:

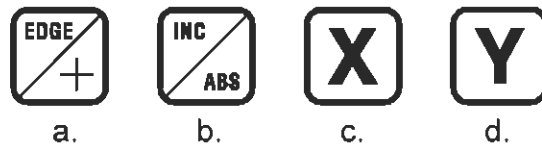

- a. Press the **EDGE/+** key if the indicator light is on to turn it off.
- b. Press the **INC/ABS** key if the light is on to turn it off.
- c. Press the **X** key. The **X** axis display will be zeros.
- d. Press the **Y** key. The **Y** axis display will be zeros.

These steps have established the current position as absolute 0, 0 and also as the point from which incremental distances will be measured.

ZEROING AN AXIS

In Edge Mode, you cross the edge you wish to zero on, and press the appropriate axis key (X or Y). That edge will be the new zero.

Perform these operations in each of the three targeting modes, zeroing one axis on an edge at a time. This will make more sense to you after you have practiced a few times.

TARGETING POINTS

You may have read this paragraph before but it bears repeating because it is important that you know how to properly target a point.

“Targeting a point” is the process of telling the QC-2000 that you wish to include a particular point in the current measurement calculation.

In this section of this manual you will be using an edge detector or crosshairs. With the system in the Auto Edge Mode configuration you only need to cross an edge of the part you are measuring. For each crossing you will hear a "beep"; if you are in a measuring routine you will see the point entered.

If you are in the manual edge mode align the crosshairs on the feature you are measuring (such as the circumference of the circle) and then press **ENTER**. (See Edge Calibration.)

If you have a QC-22X5, you need to properly calibrate the edge sensor. To do so, press the **4/CAL** key, then select Auto Cal and follow the prompts. See the Edge Detector Usage in the Option Section.

SELECTING THE EDGE DETECTOR

Before you can use the Edge Detector, you must tell the QC-2000 that you wish to change from the crosshairs to the Edge Detector. To accomplish this press the **EDGE/+** key and make sure the LED above the key is on.

If you do not have the Edge Detector Option on your system skip Cross Cal section.

CROSS CAL

Note: Auto Cal should be performed prior to calibrating the crosshairs. See page 24 of OPTION Section.

The QC-22X5 allows you to switch back and forth between using either the crosshairs or the edge detector. In order to do this, the QC-22X5 must know how far apart the edge detector's screen sensor and the crosshairs are. This calibration must be done every time you move the edge detector's screen sensor or change magnification.

You may use either circle on the Demo slide to probe a circle for this calibration.



a.



b.

"Cross Cal "



c.

"Probe Edge Circ"



d.

CROSS CAL (CONTD.)

"Probe Cross Circ"



e.

f.

- a. Press the **4 CAL** key.
- b. Press the **Down Arrow** until **Cross Cal** (Cross Hair Calibration) is displayed, then press **ENTER**.
- c. The message window displays **"Probe Edge Circ."**
Probe the edge of the circle using the edge detector, targeting 3 to 50 points.
- d. Press **FINISH**.
- e. The message window displays **"Probe Cross Circ."**
Probe the circle using the crosshairs, targeting 3 to 50 points.
- f. Press **FINISH**.

You can now switch between different targeting modes (Crosshairs, Edge, and Auto Edge) even in the middle of any Multi-Point calculation and obtain accurate results.

If you change magnification often, you may wish to write a user program to change from one magnification to another magnification in the crosshair calibration.

POLAR MODE

The QC-2000's Polar Mode simultaneously computes the straight-line distance from the current datum to any point, and the angle this line makes with the positive X axis. Follow this procedure to see how it works.



a.

If the message window reads X and Y instead of R, < press the POL/CART key to enter Polar Mode.

Notice the entries in the Feature List that had X and Y labels have been changed to R and <. The X, Y points (which were measured relative to the current datum), become R, < points, also measured from the current datum.

Using the UP and DOWN ARROW keys, find a feature with an R, < component. Look in the DRO Windows to see how the feature's information is displayed in Polar Mode.

Press the POL/CART key to return to Cartesian Mode. Both the Feature Axes Windows and the Feature List display the information in an X, Y format.

Demonstration

Don't let polar measurements confuse you. The polar coordinates merely change the way the information is shown, it's still the same information, just as 1 inch and 25.4 millimeters are two different ways of expressing the same length.

In Cartesian measurements the distance is expressed with a pair of coordinates X and Y. This is the system we are most familiar with. In a polar system we express a distance using a pair of coordinates r and α . These represent the radial (straight line) distance and the angle magnitude.

Surveyors use polar coordinates all the time. When land is surveyed the plot is not defined by Latitude and Longitude (a version of Cartesian measurement) for all the corners of the property. Rather, it is defined by polar measurement. The survey will read "from boundary marker X23 (the origin) northeast $36^{\circ} 52'$ for a distance of 65.1 feet". This is polar measurement, where distances are denoted by traveling some distance in some direction from an origin. The surveyor used north as 0° , but north is not a standard direction when it comes to comparators so we use the positive X axis as our 0° line.

Scientific convention dictates that we use the counter clockwise direction (left hand rule) to measure angles. So if you swing from the positive X axis around to the positive Y axis the angle increases.

Polar measurements can be very useful for things like point to point distance measurements (when the line isn't aligned with the X or Y axes of the part) and for quick angle measurements.

SKEWING THE PART

The accurate measurement of a part assumes that you have the part perfectly aligned on your comparator's bed. An improperly aligned or "mis-skewed" part means an inaccurate measurement. Your first step should always be to align or skew the part.

When skewing the part, you will probe an edge, preferably a horizontal edge. The more points you enter and the further apart they are, the more exact your results will be. You may target between 2 and 50 points, for this example enter 3 points. The process is described briefly in the following procedure.

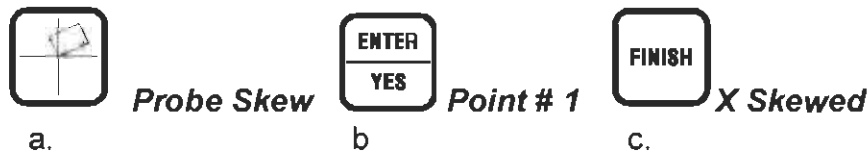

- a. Press the **SKEW** key.
"Probe Skew" appears in the message window.

Demonstration

SKEWING THE PART (CONDT)

- b Target the 3 points on the bottom (X axis) of the part spreading the points out across the edge. After each point has been probed the display will read "Point #1", "Point #2" etc.
- c. Press **FINISH** (when you have entered the points for the X axis). "X Skewed" (or "Y Skewed" if the angle is greater than 45 degrees) appears in the message window. The QC-2000's incremental point will be set to 0,0.

The part has now been skewed, or electronically rotated. Even if the edge of the part is not perfectly parallel with the axes of the comparator, the QC-2000 will automatically compensate for the part's misalignment.

When you Skew a part, the part must be placed within 45° of true orientation if not the axes orientation may change. If the part is not perfectly parallel with the axes of the comparator the QC-2000 will automatically compensate for that fact.

If your part is misaligned with respect to the travel of your machine, you will notice that more than one DRO axis display will change, as you move along the axis. This is because the QC-2000 knows you are moving diagonally with respect to the part.

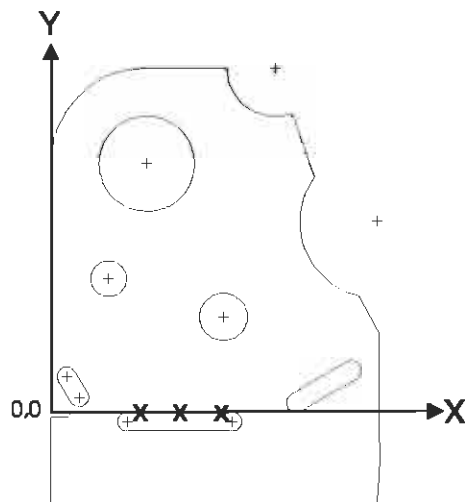

Figure 2-2 Skewing the part.

FORWARD - BACKWARD ANNOTATION

Forward Annotation is the process of designating a specific number of points for the targeting of a feature. When that number of points is reached, the user program automatically advances the system to the next program step.

Backward Annotation is the process where the program does not indicate a pre-determined number of points targeting a feature. When the program reaches the targeting step, it waits for operator input by way of an **ENTER** or **FINISH** keypress to advance the system. When the operator has determined that a sufficient number of points (ranging from 2 to 50), have been targeted, he presses the appropriate key.

If you wish to change the annotation procedure, perform the following steps:



a.

Enter Setup?



b.

Clear



c.

ANNOTATION



d.

Back. Annotate



e.

Forw. Annotate



f.

Forw. Annotate

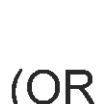

g.

Point Pts.# ?

(OR)



h.

Value:



i.



Line Pts.#?



j.

Value:



k.

Circle Pts.#



l.

Value:



m.

Circle Pts #?



ANNOTATION



. Current Position

n.

ANNOTATION (CONTD)

- a. Press the **5/SETUP** key on the QC-2000's Numeric Keypad.
"Enter Setup?" appears in the message window.
- b. Press **ENTER/YES**.
"Clear" appears in the message window.
- c. Press the **DOWN ARROW** until *"Annotation"* appears in the message window.
- d. Press **ENTER**.
"Back Annotate" appears in the message window.
- e. Press the **DOWN ARROW**.
"Forw Annotate" appears in the message window.
- f. Press **ENTER** if you wish to use Forward Annotation. *OR* Press the **DOWN ARROW** to review the point defaults.
- g. *"Point Pts. #"* ? appears in the message window.
- h. Press **ENTER**.
"Value:" appears in the message window. Use the numeric keypad to enter the new number of points.
- i. Press **ENTER**, Then Press **DOWN ARROW**.
"Line Pts.#" appears in the message window.
- j. Press **ENTER**.
"Value:" appears in the message window. Use the numeric keypad to enter the new number of points.
- k. Press **ENTER**, Then Press **DOWN ARROW**.
"Circle Pts.#" appears in the message window.
- l. Press **ENTER**.
"Value:" appears in the message window. Use the numeric keypad to enter the new number of points.
- m. Press **FINISH**.
"Circle Pts" appears in the message window.
- n. Press **QUIT** twice to exit the Setup Menu.
"Current Position" appears in the message window.

POINT MEASUREMENT

Points are the easiest to probe or construct because they require very little interaction between the user and the QC-2000. Follow these steps to measure several points on the part.



- a. Press the **POINT** key. "*Probe Point*" is displayed in the message window. .

If the message window displays "*Probe Point*" the QC-2000 is in Backward Annotation. After the each point has been probed the display will read "*Point #1*", "*Point #2*" etc.

If the QC-2000 is in Forward Annotation, the message window will read "Probe Point #" (default point setting and count down with each point entry). The operator may override the default setting by pressing the **POINT** key to increase the number of points.

For purposes of this demonstration we will assume that from here on you are in backward annotation.

- b. Target a point on the part. The point will be entered into the point storage list. (The **FINISH**, **ENTER**, **CANCEL** and **QUIT** keys are active.)
Repeat step b. for each additional point, up to 50 total.

Average Point

The average point, or "multi-point point" is a way to obtain more accuracy in point measurements by targeting the point several times and then averaging all the positions entered when generating the POINT feature. As in other multi-point measurements, up to 50 points may be entered. Average points (up to 50) may also be constructed by entering features containing positional information from the feature list.

CONSTRUCTION is not allowed when you PROBE a feature. Refer to the last paragraphs in this section for Construction information.

- c. Press **FINISH** to indicate that you have completed the operation.

When the **FINISH** key is pressed, the QC-2000 will calculate the feature and display it as "a1" pushing other features, if any exist. See Pushing Features in Section I.

Demonstration

When you measure a point, you will see X/Y in the message window. The X and Y data displayed in the axes windows represents the X and Y distance from the current datum to the selected point. Press the **MORE** key, the +T data is displayed in the X axis window.

LINE MEASUREMENT

The QC-2000 can also measure lines. Targeting between 2 and 50 points, the QC-2000 will calculate the line which best fits those points as well as providing Form Data.

Let's measure the line formed by the part's skewed axis and the left face as shown in Figure 2-3.



- a. Press the **LINE** key.
"Probe Line" is displayed in the message window.
- b. Press **ENTER**.
"Point #1" is displayed in the message window.
You must target at least 2 points (up to 50 points if you wish) to define the line.
- c. Press **FINISH** to signal the end of the line measurement.
"a1 Line <" is displayed in the message window.

When the **FINISH** key is pressed, the QC-2000 will calculate the feature and display it as feature "a1" pushing other features. See Pushing Features in Section I.

When the QC-2000 calculates a line, it also computes the X, Y point on the line that lies closest to the Absolute Datum. However, this point, like all other points, is displayed relative to the current datum (either Absolute or Incremental). Pressing the **MORE** key will display the X,Y information.

The < entry in the message window represents the angle the line makes with the positive X axis of the Reference Frame.

Press the **MORE** key to view the coefficients/form data. The +T data is displayed in the X axis window. The -T data is displayed in the Y axis window.

These numbers tell how close the worst "outside" and "inside" points were to the best-fit construction. The +T measurement shows you where the "worst outside point" was; -T shows where the "worst inside point" was located.

The +T and -T meaning for this feature is as follows:

- +T: Straight-line distance from worst point (on side of line *away from* the current datum) to best-fit line.
- T: Straight-line distance from worst point (on side of line *facing* the current datum) to best-fit.

Demonstration

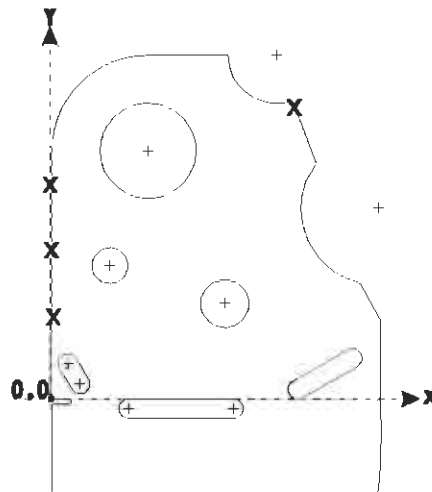

Figure 2-3 Line Measurement

CIRCLE MEASUREMENT

The QC-2000 enables you to make very precise calculations about any circle or arc of circle. Given anywhere from 3 to 50 points, the QC-2000 can calculate the circle's center and radius, as well as Form Data. (Note, refer to Multi-point Measurement paragraph in the Reference section for degrees arc information.)

For this example use the large circle in the demonstration part and follow these steps:



Probe Circle

a.



Point #1

b.



a1 Circle

c.

- a. Press the **CIRCLE** key.
"Probe Circle" is displayed in the message window.
- b. Target a point on the circumference of the circle.
Press **ENTER**; *"Point #1"* is displayed in the message window.
Target additional points on the circumference of the circle until you have entered between 3 and 50 points.
- c. Press **FINISH** when you have entered enough points.
"a1 Circle" is displayed in the message window.

Demonstration

Upon completion of this feature the radius datum will be displayed in the X display and the diameter in the Y display. Pressing **MORE** gives the X,Y location of the center of the circle relative to the current datum.

After you press **FINISH**, the QC-2000 will place the resulting circle feature at the bottom of the Feature List.

Press the **MORE** key to view the coefficients/form data. The +T data is displayed in the X axis window. The -T data is displayed in the Y axis window.

The +T and -T meaning is as follows:

- +T : Distance from worst point outside best-fit circle to best-fit circle.
- T : Distance from worst point inside best-fit circle to best-fit circle.

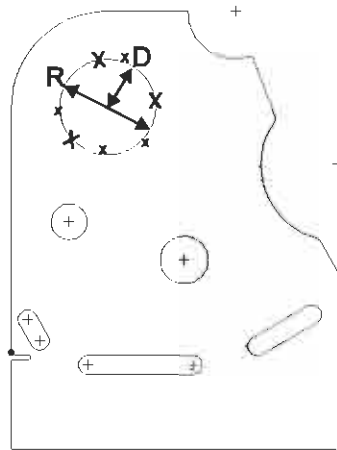

Figure 2-4. Circle Measurement.

DISTANCE MEASUREMENT

Another function performed by the QC-2000 is distance measurement. The QC-2000 can calculate the Cartesian or polar distance between two points.

In this example of the part demonstration we will measure the height of the part (the dimension of the part along the Y axis) using the following steps.



Probe Dist

a.



Point #1

b.



a1 Distance X/Y

c.

Demonstration

- a. Press the **DIST** key.
"Probe Dist" is displayed in the message window.
- b. Target a point on the demo part's edge near point 1 of Figure 2-5.
"Point #1" is displayed in the message window.

Target a point on the demo part's edge near point 2 of Figure 2-5.
"Point #2" is displayed in the message window.

Note: If more than 2 points are entered the message window will read "No more points" and the system will not accept more than 2 points.

- c. Press **FINISH** to indicate the completion of the distance measurement.

If you are in the Cartesian mode, X and Y will be displayed. If in the Polar mode the straight distance between two points is displayed as R and A: Where A is the angle and R is the distance.

The MORE key will be inoperative because there is no additional information to display about the distance.

The order of entry of the two points is most important. If the Y distance displayed is 1.8in, it would have been -1.8in if the points had been entered in reverse order.

Note: Distances are usually generated as relations between existing features. Constructions are explained later in this section, as well as in *The Reference Guide*.

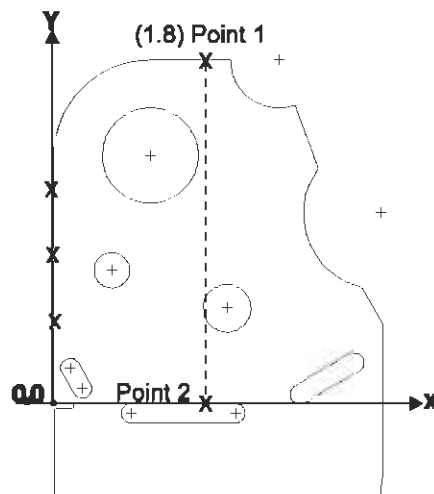
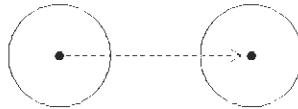

Figure 2-5 Distance Measurement.

CHANGING CONSTRUCTED DISTANCES

When constructing a Distance, the result will always be the center point measurement of the two features used in the construction. There will be two displays added to the constructed distance display for a total of three. The affected constructions will be the circle/circle, circle/line, circle/point distances. Since the parent features of constructed distances are not retained in the QC-2000, the radii of the circle(s) will be stored with the distance feature. When the distance is initially displayed, the distance will be shown in the message window as "a1 Distance X/Y." If the MORE key is pressed, the next display will be "a1 Farthest X/Y." Pressing the MORE key again will display "a1 Nearest X/Y." Of course, in the Polar mode the X/Y will be replaced by R/A. The feature type will always print as a "Distance" not as a "Nearest" or "Farthest." Below, is a diagram of what you would see if you were to view these distances between two circles.

Center - When a *Distance* between 2 circles is constructed, the result will always be the Center point distance between the two Circles or a Circle and another feature.



Nearest - Pressing the MORE key will give you the Nearest distance between two Circles or a Circle and another feature.

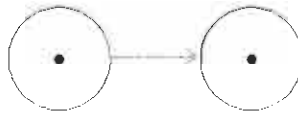

Farthest - Pressing the MORE key again, will give you the Farthest distance between two Circles or a Circle and another feature.

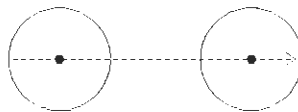

Annular Ring - The calculation of the nearest and farthest distances varies if the two circles make up an annular ring. To determine whether the construction is an annular ring, find the polar distance between the two circles. If this distance is smaller than or equal to the *largest* radius minus the *smallest* radius, then the system is an annular ring. In other words, one circle is completely inside the other. Min and Max distances will be shown as below.

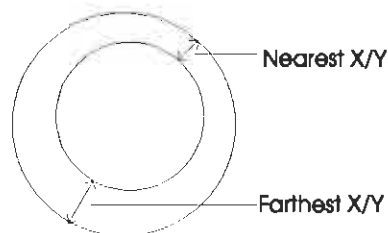

ANGLE MEASUREMENT

When an angle is probed, the *Included Angle* will be determined and displayed in the X axis window as Angle one. The calculation of the *Included* angle depends upon knowing where the line end points are.

Angle 2 is shown in the Y display and is known as the *Excluded Angle*. Press **MORE** to view the data for angles 3 and 4.

When an angle is probed or constructed, the **Vertex** will be stacked in the temporary feature list. The point feature will be placed in the list first, and then the angle feature, so that after the angle measurement is completed, the angle feature is being displayed.

FOR EXAMPLE: After the measurement is complete, the feature list will read:

a1 *Angle* <12... Now press the up arrow

a2 *Point* XY The Vertex is displayed in the X and Y axis window

Before you begin measuring Angles, you should decide if you want the **Vertex** point to be automatically generated for angle measurements. This function is factory defaulted as **NO** (disabled) and can be turned on in the Supervisor Setup Mode.

To enable/disable the Vertex function:



"Enter Setup?"

a.



"Clear"

b.



"Super"

c.



"Password :"

d.



"Auto Setup "

e.



"Vertex Pt: Yes/No"

f.



"Vertex Pt: Yes or

g.



"Vertex Pt: No"



"Finish"

h.



"Quit"

i.

- a. Press the **SETUP (5)** key on the QC-2000's Numeric Keypad.
"Enter Setup?" appears in the message window.
- b. Press **ENTER** .
"Clear" appears in the message window.
- c. Press the **DOWN ARROW** until "Super" appears in the message window.

Demonstration

- d. Press **ENTER** .
"Password" appears in the message window.
- e. Enter the Password (Supervisors Code) using the Numeric Keypad.
"Auto Setup" appears in the message window.
- f. Press the **DOWN ARROW** to step thru the categories until the *Vertex: Yes/No* appears in the message window.
- g. Press **CANCEL/NO** to turn off the Vertex function or **ENTER/YES** to enable it.
- h. Press **FINISH** to complete the selection
- i. Press **QUIT** to exit the *SUPER* menu.

To measure an Angle:

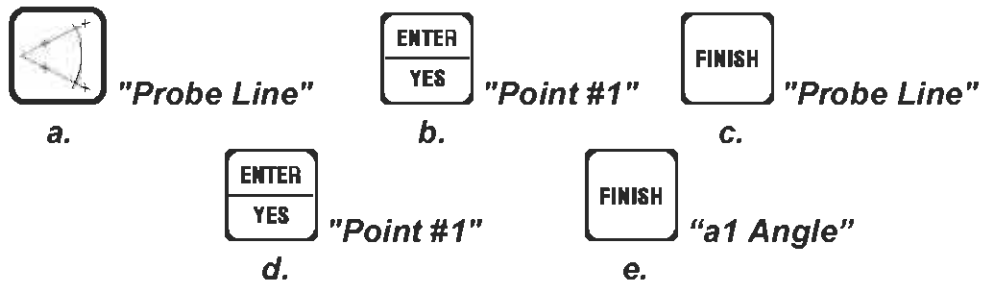

- a. Press the **ANGLE** key.
"Probe Line" is displayed in the message window.
- b. Target between 2 and 50 points on line 1 of the demo part
"Point #1" is displayed in the message window.
- c. Press **FINISH** when you have entered enough points.
"Probe Line" is displayed in the message window.
- d. Target between 2 and 50 points on line 2 of the demo part (see Figure 2-6).
"Point #2" is displayed in the message window.
- e. Press **FINISH** when you have entered enough points.
"a1 Angle" is displayed in the message window.

The QC-2000 will calculate the resulting angle relation and the vertex point (if turned on) and place the results at the bottom of the Feature List.

Demonstration

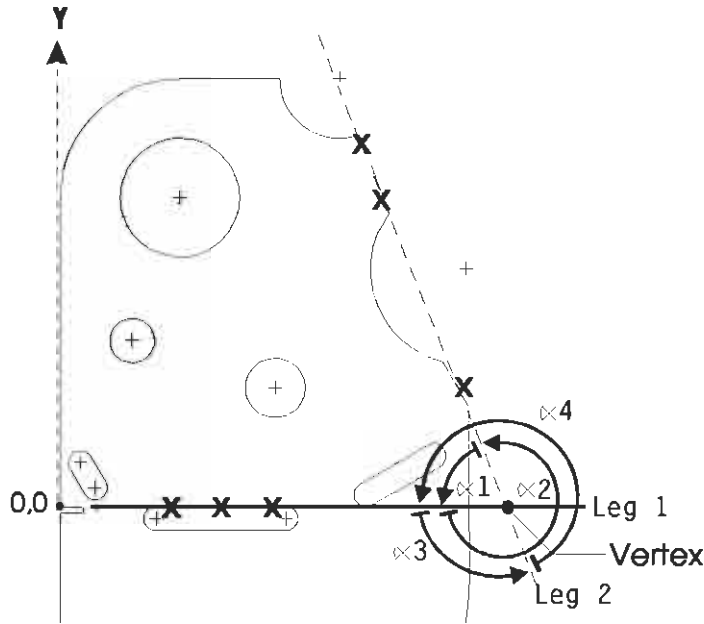

ANGLE 1 = Included Angle
Less than 180°

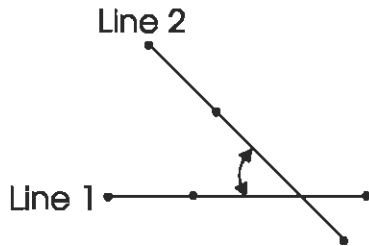

ANGLE 2 = Excluded Angle
360° Minus the Included Angle

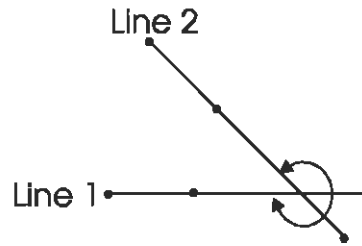

ANGLE 3 = Complimentary
Angle

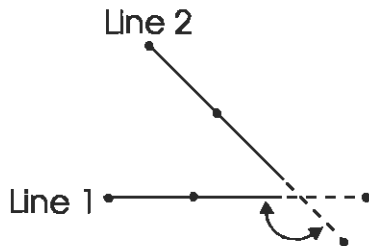

ANGLE 4 = 180° Plus
Included Angle

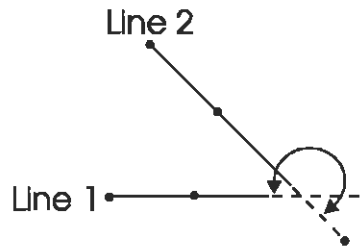

(Figure 2-6 - Finished Angle)

Note: Angles are generated as relations between existing features (usually two lines).

CONSTRUCTIONS

Constructing a feature is merely the process of combining existing features to generate a new feature. Here are several examples of common constructions. The X's represent previously generated points.

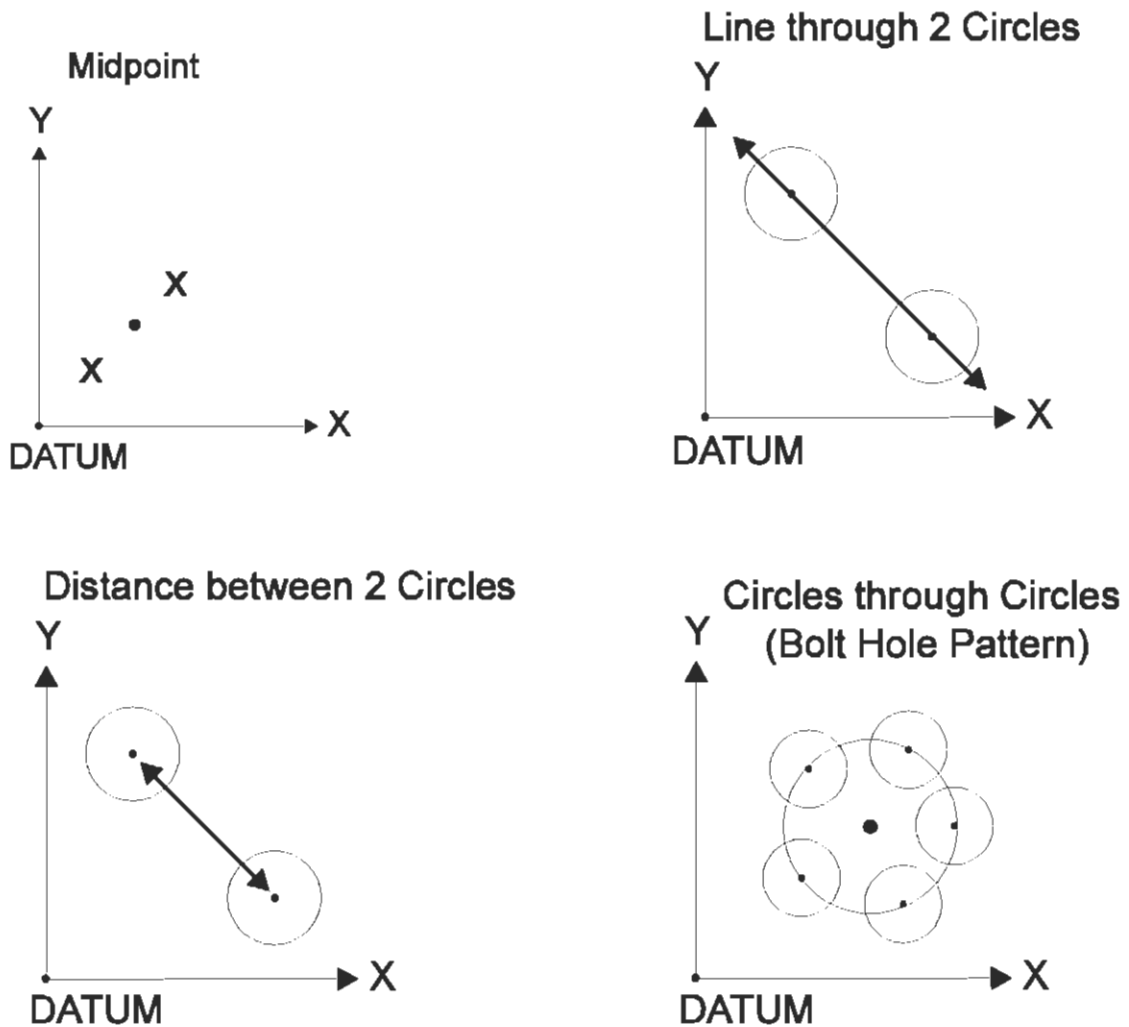

Figure 2-7. Sample Constructions.

If you press a measure key and then press the **8/UP ARROW** key or the **RECALL** key, the QC-2000 will know that you are going to **CONSTRUCT** a feature. See Recall.

When you press **ENTER** to select a feature to be used in a construction, the message window indicates that the feature has been selected with a check mark.

RECALL

RECALL-RECALL performs an automatic up arrow and select. Pressing **ENTER** on a feature already selected also performs an auto up arrow and select.

For this example, let us use the "distance between circles" construction (see Figure 2-7). We'll use two complete circles found on the Quickie Slide and follow the steps' a. through e. for constructing features listed in the following paragraph.

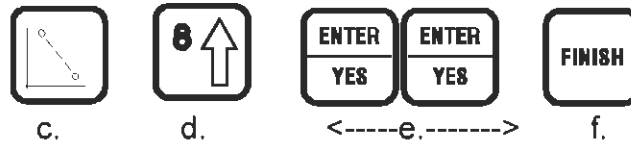

- a. Probe one of the circles as described in the *QC-2000 Demonstration*.
- b. Probe the other circle.
- c. Press the **DIST** key.
- d. Press the **UP ARROW** key.
- e. Press **ENTER** twice to select the two circle features. A check mark (✓) appears next to each feature, indicating its inclusion in the construction.
- f. Press **FINISH**.

The distance relation generated is the distance between the two circles' centers.

A comprehensive list of feature constructions allowed by the QC-2000 is given in the "General Constructions Allowed" paragraph of the Reference Section.

PRINT ALL FEATURES

We can all guess that pressing the *Print* key will print the current displayed feature. The QC-2000 also has the capability of printing **all** features in the list, including the temporary features (from the lowest to highest). The permanent features will be printed in order (from lowest to highest).

Printing the features in the feature list takes more than one key press but, you can always create a program and assign it to a front panel key (3, 6, or 9).

To select Print all Features:

1. Press the 5 key "*Enter Setup*" appears in the window.
2. Press **ENTER**; "*Clear*" will appear in the window.
3. Press the DOWN ARROW key until "*Print all feats*" appears in the window.
4. Press **ENTER**; all features will be sent to the printer via the RS232 port.

USING MEASURE MAGIC

What is Measure Magic? -- This function automatically creates the correct geometric features simply by entering points. Of course, there are some simple rules and probing techniques to follow, but measuring a part will become so fast and easy you'll probably want to use it most of the time.

Before you Begin

Before you begin using Measure Magic, the user must decide whether they wish to include *RELATIONS* in the session. To include relations when using Measure Magic, you **must** turn on "**Relations**" (**Relations: Yes**) under the *Supervisor Menu*.

If Relations is off (**Relations: No**), Measure Magic will not generate any Distances or Angles. When it is on, a 2 point line will be generated as a Distance, and Angles will now be generated if probing technique is correct.

Please refer to the Supervisor Section to change your Relations, or the Reference Section for more information about Measure Magic.

Using Measure Magic

Measure Magic operates in two different modes.

- **Singular Mode** - you will be able to probe points on one feature, and Measure Magic will calculate information on that one feature. Measure Magic is now deactivated and you can now select any other measurement function.
- **Auto Repeat Mode** - Allows you to probe an unlimited number of features until you choose to deactivate Measure Magic by press the CANCEL/NO key. With Measure Magic in the *Auto Repeat Mode*, just probe features then press the FINISH button or footswitch and see your productivity soar. Measure Magic lets you push the work, not the buttons.

Singular Mode Measure Magic



"Enter Setup?"

a.



"Clear"

b.



"Measure Magic?"

c.



"Probe Feature"

d.

MEASURE MAGIC (CONTD)

- a. Press the **SETUP (5)** key on the QC-2000's Numeric Keypad.
"Enter Setup?" appears in the message window.
- b. Press **ENTER** .
"Clear" appears in the message window.
- c. Press the **DOWN ARROW** once.
"Measure Magic?" appears in the message window.
- d. Press **ENTER** .
"Probe Feature" appears in the message window and the 5 measurement function key will be lit.

Note: *DIST* and *ANGLE* will only light if *Relations:Yes* is selected.

Now, probe points on any geometric feature pressing the **FINISH** button after the measurement is complete.

Auto Repeat Mode

In this mode, the QC-2000 can be utilized in two different ways. The first of course is the Auto Repeat Mode; allowing several features to be measured without repeatedly pressing a measurement function key.

To turn on the Auto Repeat Mode:

- Follow steps a. through d. as above.
- Once in Measure Magic, simply press any one of the lit function keys.

In most cases, operators will be using the Measure Magic function because they have quite a few features to measure. This also means they will probably want to **STORE** the features. By pressing the **RECALL** key instead of a lit function key, the Auto Repeat will become **Auto Repeat/Auto Store**.

In this mode, the features will automatically be stored in permanent memory and will be accessible by selecting the **RECALL** key and entering the appropriate 2 digit number.

QUADRA-CHEK 2000

SECTION III USER PROGRAMMING

PREVIOUS READING

Before reading this section you should read *The QC-2000 Demonstration* and *The QC-2000 Reference Guide*. These sections provide the information vital to understanding User Programming.

ABOUT THIS SECTION

User Programming refers to your ability to create programs (sequences of actions for the QC-2000 to carry out) which assist you in measuring the features of various parts you handle every day.

The steps and concepts described here are summarized in the *Reference Guide*. After reading User Programming, the *Reference Guide* should be sufficient to refresh your memory when you begin to create your own User Programs.

ABOUT USER PROGRAMS

The "standard" QC-2000 offers sufficient memory to store up to a maximum of 250 program lines of instructions. By using this programming capability, you may create "electronic instructions" to automatically measure the features of the parts you commonly deal with. These instructions, called "User Programs" or just "programs," automate the sequence of key presses needed to examine a part, leaving you free to concentrate on targeting points and interpreting the results.

To help you learn to use the programming system, we'll walk through the creation, modification, and execution of a User Program designed to find the distance between two circles located on the Quickie Slide. The user programs are labeled using a two digit identifier, i.e., 00, 01, 02 up to 99 for a total 100 programs.

The concepts and exercises covered here will help you create programs to perform most any repetitive task. As would be expected for any powerful system, the more time you spend learning it now, the greater your rewards will be in the future.

CREATING USER PROGRAMS

Creating a program to measure a feature is almost as easy as measuring the feature itself. The following are the four basic steps for creating a program.

1. Tell the QC-2000 to start recording the program.
2. Name the program.
3. Perform the measurements.
4. Tell the QC-2000 to stop recording the program.

FORWARD - BACKWARD ANNOTATION

Forward Annotation in a user program is the process of designating a specific number of points for the targeting of a feature. When that number of points is reached, the user program automatically advances the system to the next program step.

Backward Annotation in a user program is the process where the program does not indicate a predetermined number of points targeting a feature. When the program reaches that step it waits for operator input by way of a **FINISH** keypress to advance the system. When the operator has determined that a sufficient number of points (ranging from 2 to 50) have been targeted, he presses the **FINISH** key.

SETTING BACKWARD ANNOTATION

When you are creating the following program, be sure that you are in Backward Annotation. Use the following procedure to set the system in Backward Annotation.

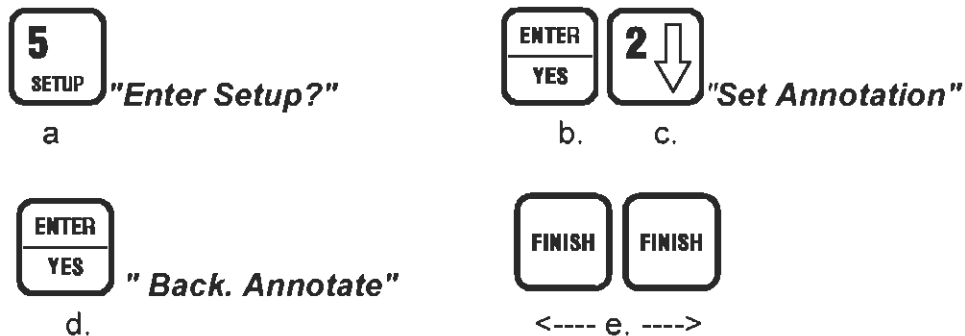

- a. Press the **5/SETUP** key. The message line displays *"Enter Setup?"*
- b. Press the **ENTER** key.
- c. Press the **2/DOWN ARROW** key until *"Set Annotation"* is displayed in the message window.
- d. Press the **ENTER** key. *" Back. Annotate"* will show in the window. Press the **ENTER** key the backward annotation default will be set.

If you wish to set the default to forward annotation, press the **DOWN ARROW**, *"Forw. Annotate"* will show in the window. Press **ENTER** to set the default .

- e. Press **FINISH** twice to get out of the Setup Menu.

Programming

If the default check mark (✓) does not appear:



- Press the **8/UP ARROW** key to return to the menu item.
- Press **ENTER** the key to set the default ("*Back. Annotate*").
- Press **FINISH** twice to get out of the Setup Menu.

DEBUGGING

QUIT keypresses may be inserted into various parts of the user program for debugging purposes. The **QUIT** keypress will stop the program to permit the operator to make changes to a specific area of the program without having to run through the whole program. The **QUIT** steps should be deleted after program editing is complete.

CREATING A PROGRAM

To create a program use the following procedure:

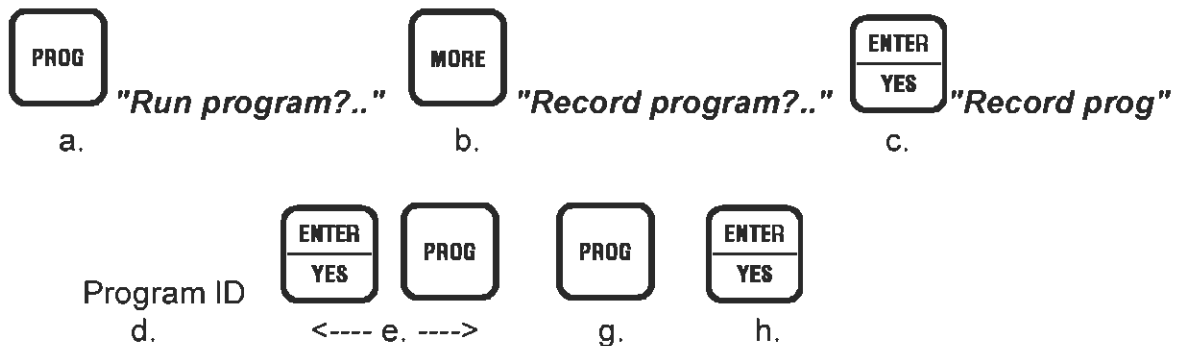

- Press the **PROG** key.
"*Run program?..*" will be displayed.
- Press the **MORE** key.
"*Record program?..*" will be displayed.
- Press the **ENTER** key.
"*Record prog:* " will be displayed.
- Enter the program ID number (using the numeric keypad).
- Press the **ENTER** key.
The **PRO** light will blink indicating that the QC-2000 is in the record mode.

Programming

- f. You are now ready to record the steps associated with this program. All you do is perform the steps you wish to be entered into the program. You may use any of the sample programs or one that you developed.
- g. Press the **PRO** key.
"Finished recording?..." will be displayed.
- h. Press **ENTER** to save the program and get out of the record mode.
When you complete this last step, the number of steps available for future use is displayed.

EDITING USER PROGRAMS

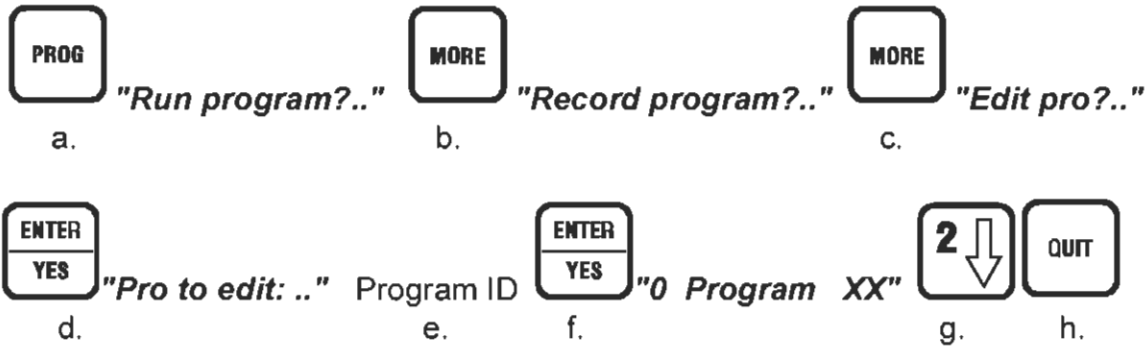

- a. Press the **PRO** key.
"Run program?..." will be displayed.
- b. Press the **MORE** key.
"Record program?..." will be displayed.
- c. Press the **MORE** key.
"Edit program?..." will be displayed.
- d. Press the **ENTER** key.
"Pro to Edit:..." will be displayed.
- e. Enter the ID of the program to be edited.
- f. Press the **ENTER** key.
"0 Program XX" will be displayed and the **PRO** light will be ON.
- g. Press the **2/DOWN ARROW** key to step thru the program.
You are now viewing the steps (key presses) that make up the program. The line number for each step is located at the beginning of the line.

Programming

NOTE: Pressing any key, except the Special Program keys: **CANCEL**, **ENTER**, **FINISH**, **QUIT**, **PRO** and **ARROW** keys, will cause that key to be inserted into the program immediately after the line that is currently displayed.

- h. Press **QUIT** to exit the editing mode without saving changes. Press **FINISH** to save any changes.

SPECIAL PROGRAM STEPS

These special steps can only be inserted into a program by pressing **PRO** and calling up the list, selecting the item using the **MORE** key and then pressing **ENTER**. **QUIT** will get you out of the list without entering a step.

SPECIAL PROGRAM KEYS

The following is a list of the Special Program keys.

8/UP ARROW	2/DOWN ARROW	CANCEL
ENTER	QUIT	FINISH
ENTER?	FINISH?	PRO

ENTER? waits for an **ENTER** key press. This step is similar to "FINISH?" except the QC-2000 waits for the **ENTER** key to be pressed before resuming program execution.

FINISH? waits for a **FINISH** key press or an auto edge crossing. This is a step used in multi-point measurement; it gives program control to the user until the **FINISH** key is pressed. When the **FINISH** key is pressed the system will revert to program execution starting with the step after "FINISH?".

PROGRAM EDITING KEYS

The following are the keys used in program editing.

8/UP ARROW and **2/DOWN ARROW** used to traverse the feature list.

CANCEL deletes the displayed program step. If line 0 is displayed the whole program will be deleted.

ENTER or **PRO** displays the Special Program step. (Puts you into the special programming keys.) Refer to the Special Programming Steps.

FINISH exits the editing mode and automatically saves the changes.

QUIT exits the editing function. The message line prompts asking if you want to save the changes.

EXECUTING USER PROGRAMS

Now that you have covered how to create and edit a program, you need to know how to run a program. You can execute any of the stored programs by using the following steps:

RUNNING A PROGRAM

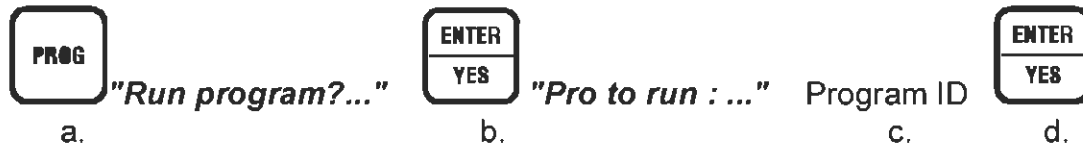

- a. Press the **PROG** key.
"Run program?..." will be displayed.
- b. Press the **ENTER** key.
"Pro to run : ..." will be displayed.
- c. Enter the ID of the program to be run.
- d. Press the **ENTER** key.

The program will run as you recorded it. The **PRO** light will be ON for as long as the program is running.

Using subroutine programs can simplify larger programs. If you had a "measure slot" program, you could include it as a step in other programs. This would eliminate the need to enter those steps in the programs that would use it. Any changes made to routine would be reflected in all programs that used it.

When creating programs that execute other programs, user programs can not be more than 5 recursions, meaning that a user program can not repeat itself or any other program more than 5 times.

DELETING A USER PROGRAM

When you wish to delete a user program use the following procedure.

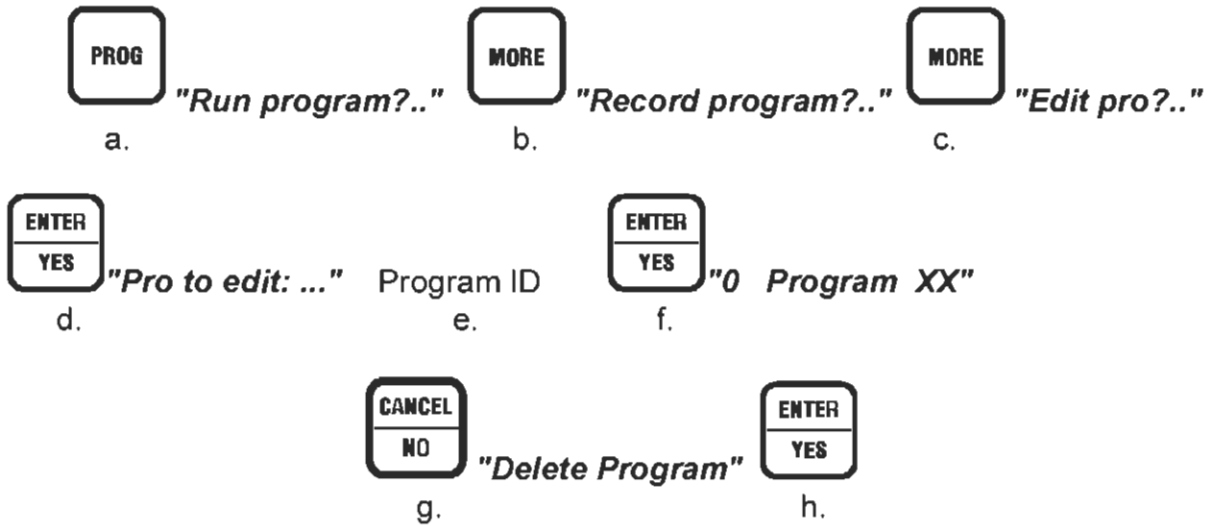

- a. Press the **PROG** key.
"Run program?..." will be displayed.
- b. Press the **MORE** key.
"Record program?..." will be displayed.
- c. Press the **MORE** key.
"Edit program?..." will be displayed.
- d. Press the **ENTER** key.
"Pro to Edit:..." will be displayed.
- e. Enter the ID of the program to be edited.
- f. Press the **ENTER** key.
"0 Program XX" will be displayed and the **PRO** light will be ON.
- g. Press the **CANCEL** key while on the 0 line to delete the program.
- h. Press the **ENTER** key to verify the question to cancel.

PRINTING PROGRAMS

Your QC-2000 has the ability to download the programs stored in memory through a RS-232 port to a printer or computer. Use the following procedure to download the programs.

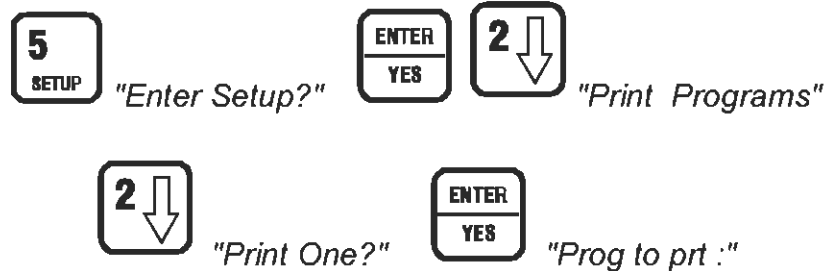

Press the **SETUP** and **ENTER** keys. Press the **Down Arrow** until the message window shows *"Print Programs"*. Press **ENTER** the message window shows *"Print One?"* Press **ENTER**. The QC-2000 will ask you *"Prog to prt :"*. Enter the program number you want to download and press **ENTER**. The program will be downloaded through the RS-232 port. If you want to download other programs, repeat this procedure (i.e., pressing **ENTER** and entering the program number). Press **QUIT** to exit the program.

Note: *If the RS-232 port parameters (baud rate, parity, word length and stop bits) are not set properly the QC-2000 will download garbage or not download at all. Refer to the Serial Port Set Up. Press **QUIT** to stop the QC-2000 from printing.*

The following is a sample print format for a program that finds the distance between 2 points.

```

-----
0  Program 99
1  Point
2  Finish?
3  Store
4  0
5  1
6  Enter
7  Point
8  Finish ?
9  Store
10 Enter
11 Distance
12 Recall
13 0
14 1
15 Enter
16 Recall
17 0
18 2/Down Arrow
19 Enter
20 Finish
21 End Program
-----
    
```

SAMPLE USER PROGRAMS

This sample program finds the distance between any two points and lists the results as a DISTANCE feature/relation at the bottom of the feature list.

<u>STEPS</u>	<u>EXPLANATION</u>
0. Program 0	Program Label
1. Distance	Press Distance Key
2. Finish?	Probe Point 1
	Probe Point 2
	Press Finish
3 End Program	Program Completed

CIRCLE, CIRCLE, DISTANCE

This program finds the distance between any two circle centers and lists the results as a distance feature on the feature list.

<u>STEPS</u>	<u>EXPLANATION</u>
0. Program 0	Program label
1. Circle	Probe first circle
2. Finish ?	Wait for FINISH keypress to complete circle
3. Store	Store as feature no. #01
4. 0	
5. 1	
6. Enter	
7. Circle	Probe second circle
8. Finish ?	Wait for FINISH keypress to complete circle
9. Store	Store as feature no. #02
10. 0	
11. 2	
13. Enter	
14. Distance	Construct distance.
15. Recall	Recall the first circle
16. 0	
17. 1	
18. Enter	Automatically selects feature no. #01
19. Enter	Selects feature no. #02
20. Finish	Finish distance construction
21. Store	Store as feature no. #03
22. 0	
23. 3	
24. Enter	
25. End Program	Program Completed.

BOLT HOLE CIRCLE, 5 HOLE

This program finds the best fit circle from five circle centers and lists the results as a circle feature on the feature list.

<u>STEPS</u>	<u>EXPLANATION</u>
0. Program no. #0	Program label
1. Circle	Probe first circle
2. Finish ?	Wait for FINISH keypress to complete circle
3. Store	Store as feature no. #01
4. 0	
5. 1	
6. Enter	
7. Circle	Probe second circle
8. Finish ?	Wait for FINISH keypress to complete circle
9. Store	Store as feature no. #02
10. 0	
11. Down Arrow	
12. Enter	
13. Circle	Probe third circle
14. Finish ?	Wait for FINISH keypress to complete circle
15. Store	Store as feature no. #03
16. 0	
17. 3	
18. Enter	
19. Circle	Probe third circle
20. Finish ?	Wait for FINISH keypress to complete circle
21. Store	Store as feature no. #04
22. 0	
23. 4	
24. Enter	
25. Circle	Probe fifth circle
26. Finish ?	Wait for FINISH keypress to complete circle
27. Store	Store as feature no. #05
28. 0	
29. 5	
30. Enter	

Programming

SAMPLE USER PROGRAMS (CONTD)

31.	Circle	Construct the bolt hole circle
32.	Recall	Recall the first circle
33.	0	
34.	1	
35.	Enter	Automatically selects feature no. #01
36.	Enter	Selects feature no. #02
37.	Enter	Selects feature no. #03
38.	Enter	Selects feature no. #04
39.	Enter	Selects feature no. #05
40.	Finish	Finish the bolt hole circle construction
41.	Store	Store the bolt hole circle as feature no. #06
42.	0	
43.	6	
44.	Enter	
45.	End Program	End of the program

ADVANCED TECHNIQUES

CIRCLE, CIRCLE, DISTANCE - ADVANCED

This program finds the distance between any two circle centers using temporary features and lists the results as a DISTANCE feature at the bottom of the feature list.

<u>STEPS</u>	<u>EXPLANATION</u>
0. Program ID Number	Program ID Number.
1. Circle	Target First Circle.
2. Finish ?	Press Finish.
3. Circle	Target Second Circle.
4. Finish ?	Press Finish.
5. Distance	Construct Distance.
6. 8/Up Arrow	Change into List Mode.
7. Enter	Enter Second Circle.
8. Enter	Enter First Circle.
9. Finish	Finish Distance.
10. End Program	Program Completed.

QUICK PROGRAMMING REFERENCE

OVERVIEW

A program consists of a stored sequence of front panel key presses.

There is sufficient memory for 100 program lines to be stored in a standard QC-2000.

These key presses may be entered by recording them or entering them directly into the QC-2000.

The key presses may be divided among a maximum of 100 programs.

Each program is identified by a numerical id from 00 thru 99.

RECORDING

1. Press the PRO key: "Run program?..." will be displayed.
2. Press the MORE key: "Record program?..." will be displayed.
3. Press the ENTER key: "Record pro" will be displayed.
4. Enter the id of the program to be recorded.
5. Press the ENTER key. The PRO LED will blink indicating that the QC-2000 is in the record mode.
6. Press the key sequences that you want to record.
7. Press the PRO key to end the program.
8. Press the ENTER key to save the program.

RUNNING A PROGRAM

1. Press the PRO key: "Run program?..." will be displayed.
2. Press the ENTER key: "Pro to run:..." will be displayed.
3. Enter the id of the program to be run.
4. Press the ENTER key. The PRO LED will stay lit as long as the program is running.

EDITING A PROGRAM

1. Press the PRO key: "Run program?..." will be displayed.
2. Press the MORE key: "Record program?..." will be displayed.
3. Press the MORE key: "Edit program?..." will be displayed.
4. Press the ENTER key: "Pro to Edit:..." will be displayed.
5. Enter the id of the program to be edited.
6. Press the ENTER key: "0 Program XX" will be displayed.

You are now viewing the steps (key presses) that make up the program. The number at the left of the display is the step line number.

Pressing any key, excepting CANCEL, ENTER, FINISH, QUIT, PRO and the ARROW keys, will cause that key to be inserted into the program immediately after the line that is currently displayed.

QUICK PROGRAMMING REFERENCE (CONTD)

The ARROW keys allow you to traverse the list.

CANCEL deletes the displayed program step.

FINISH exits the editing function and automatically saves the changes.

QUIT exits the editing function. The message line prompts asking if you want to save the changes.

Pressing the PRO key displays a list of special program steps:

ENTER, FINISH, CANCEL, QUIT, UP ARROW, DOWN ARROW and PROGRAM,

ENTER? (waits for an ENTER key.)

FINISH? (waits for a FINISH key.)

These steps can only be inserted into a program by calling up the special step's list, selecting the item using the MORE key and then pressing ENTER. QUIT will get you out of the list (without doing anything else).

ASSIGNING PROGRAMS TO FRONT PANEL KEYS

1. Press the "5" key. *"Enter Setup"* is now displayed. Press **ENTER**.
2. Use ARROW DOWN key to scroll to *"Remote Keys"* and press **ENTER**.
3. Scroll down to "3,6,9 keys" Press **ENTER**.
"3,6,9 On: NO" is now displayed.
4. Press **ENTER** to change it to **YES**.
5. Scroll down to the key you wish to use to execute the program and press **ENTER**.
"Key Assignment:" is now displayed.
6. Press the "**PRO**" key. *"Key Program"* is now displayed.
7. Enter the program number you want assigned to this key and press **ENTER**.
The key you just defined will now run the program that you assigned to it.

EXAMPLE: Assign the 3 key to run Program 99

After steps 1 through 7 are completed, the message window will read:

3 = Program 99

8. Press **FINISH** to exit, then **QUIT** twice to you return to the "CURRENT POSITION" mode.

QUADRA-CHEK 2000

SECTION IV REFERENCE GUIDE

PREVIOUS READING

You should have read *Essential Information*, and at least started reading *The QC-2000 Demonstration* before reading this section.

ABOUT THIS SECTION

This section provides detailed information about the functions and capabilities of the QC-2000 and expands upon topics covered in the other sections.

GENERAL CONSTRUCTIONS ALLOWED

Feature construction is the process of combining existing features to generate a new feature. A feature must either be totally constructed or totally probed, it can not be generated by combining a construction and probing points.

A comprehensive list of all feature constructions allowed by the QC-2000 follows. The list given for each sub-topic represents the components of the construction. For example, under Point Constructions Allowed, "circle" means that, after pressing MEASURE and POINT you would select a single circle and press FINISH.

TYPE	YIELD
INTERSECTION	line-line, line-circle, circle-circle; returns intersection point.
DUPLICATE	all types. Duplicates feature.
EXTRACT	center of circle; point on line.
OFFSET	offset point, parallel line, offset circle.
RELATIONSHIP SYMMETRIC	distances and angles. midpoint, bisector line.
PERPENDICULAR	point or line from line-point.
COMPONENT BUILD	point-distance, point angle.

The following chart provides a comprehensive list of allowed constructions. To use the chart first determine the type of construction you wish to use, press the key for the feature you are going to calculate, then enter the two previously measured features you are using for the basis of the new feature. For instance, if you wish to find the point of intersection of two lines, first refer to the Constructions chart under point and find the intersection of two lines. Next you press the point key and enter the two lines from their current memory location.

Reference

CONSTRUCTIONS (CONTD)

The following is an example of point construct. Assume that you want to make a circle into a point. First you probe a circle, an example of which is given in the Demonstration Section. Store that circle as permanent feature No. 00. To construct a point from that circle center use the following procedure.

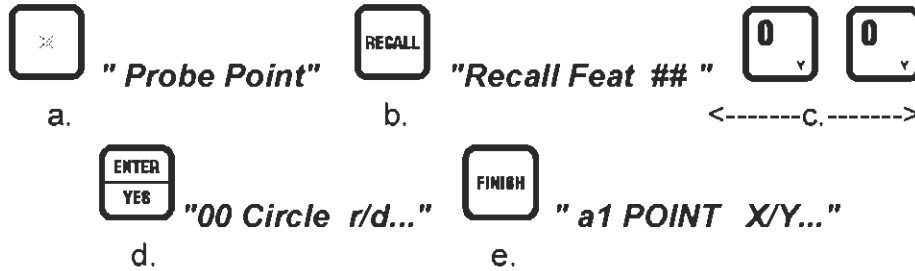

- a) Press the **POINT** key.
"Probe Point" is displayed in the message window.
- b) Press the **RECALL** key.
"Recall Feat ## " is displayed in the message window.
- c) Press the **0** key twice.
(This is the feature id of the circle.)
- d) Press the **ENTER** key.
Circle r/d..." is displayed in the message window.
- e) Press **FINISH**.
" a1 Point X/Y..." is displayed in the message window.
This feature is equivalent to the center point of the circle.

TO GET A POINT...

PRESS...

THEN SELECT...

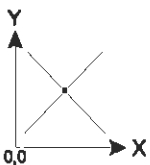

Intersection of two lines

POINT key

Line 1 and line 2

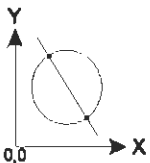

Intersection of a line and circle

POINT key

The line and the circle

CONSTRUCTIONS (CONTD)

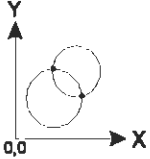
TO GET A POINT...PRESS...THEN SELECT...

Intersection of two circles. (See Note.)

POINT key

The two circles

NOTE - CIRCLE/CIRCLE INTERSECTION

The point - Circle/Circle construction gives 2 points of intersection unless there is no intersection, then an error message " No Intersection..." is displayed. To construct the midpoint, you must extract a POINT feature by constructing POINT - CIRCLE. Then construct POINT - CIRCLE/POINT.

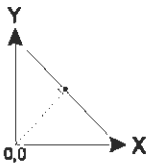

The point on a line closest to the datum

POINT key

The line

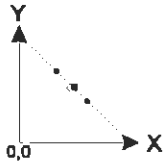

A mid-point between two points

POINT key

The two points

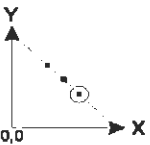

A mid-point between a point and a circle

POINT key

The point and circle

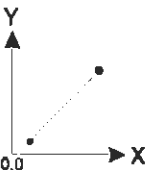

An offset point

POINT key

A point and a distance

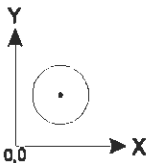

Center point of a circle

POINT key

The circle

POINT CONSTRUCTIONS (CONTD)

TO GET A POINT...

PRESS...

THEN SELECT...

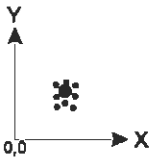

Average point

POINT key

Multiple points

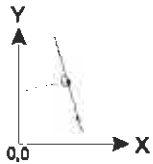

A perpendicular point

POINT key

The line and a point

TO GET A LINE...

PRESS...

THEN SELECT...

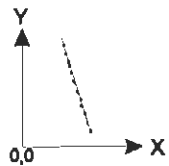

A best fit line

LINE key

Combinations of multiple circles or points

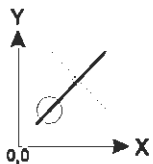

A line perpendicular to a line through a feature

LINE key

Line and circle, line and point

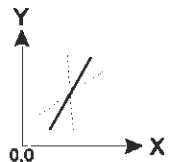

A bisector line

LINE key

Any two lines

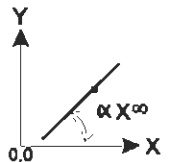

Calculated line

LINE key

The point and angle

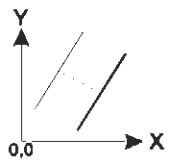

An offset line (parallel line)

LINE key

The line and a distance

CONSTRUCTIONS (CONTD)

TO GET A CIRCLE...

PRESS...

THEN SELECT...

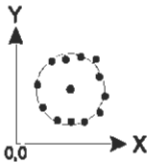

A best fit circle

CIRCLE key

Combinations of multiple circles or points

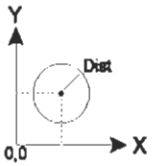

Calculated circle

CIRCLE key

The point and a distance

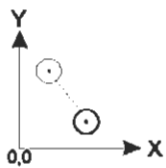

An offset circle

CIRCLE key

The circle and a distance

Constructing relationships

TO DETERMINE A DISTANCE...

PRESS...

THEN SELECT...

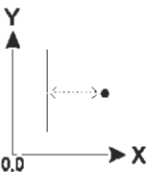

A straight line distance

DISTANCE key

Two points, a point and line, a point and circle, a line and circle

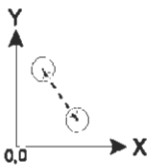

A distance between two circle centers

DISTANCE key

Two circles

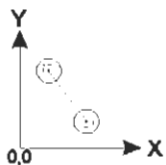

Farthest Distance

DISTANCE key

Two circles, a circle and a line, a circle and a point. Then press the **MORE** Key

CONSTRUCTING RELATIONSHIPS (CONTD)

TO DETERMINE
A DISTANCE...

PRESS...

THEN SELECT...

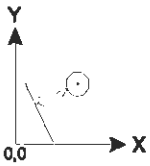

Nearest Distance

DISTANCE key

Two circles, a circle and a line, a circle and a point.
*Then press the **MORE** Key twice.*

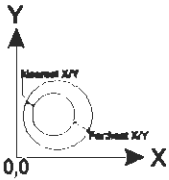

Nearest/Farthest distance of
an Annular Ring.
Sometimes called (Min/Max)

DISTANCE key

Two circles then press the
MORE key.

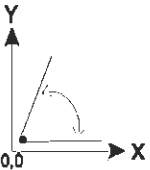

The angle and Vertex of two
lines

ANGLE key

The two lines. *The vertex
will appear in the feature list
as a point*

MORE

When three periods are seen at the end of a prompt in the message window (e.g. Record program?...) it indicates additional information may be viewed by pressing the MORE key

Pressing the MORE key while the system is displaying a feature will show the other components of the feature. Press MORE again and the system will display the form information, if there is any. The MORE key will not function in the DRO mode.

CANCEL

The QC-2000 has several Multi-Point features that require more than one point to complete. For example, the circle accepts up to 50 points, and calculates the radius and center of the circle that best fits these points.

Suppose that you are about to enter the last point of a 50 point calculation while in Auto Edge Mode and you happen to cross a stray shadow on the comparator's screen. The QC-2000 will accept that last point, and display the best fit radius as usual. But that last point was a mistake.

Don't panic! You can tell the QC-2000 to take one step back, and you can re-enter the last point. All you have to do is press the **CANCEL** key and **Point X** appears in the display window, prompting you for that last point again. Target the point and the corrected radius measurement will be displayed.

The **CANCEL** key works in all targeting modes and will save you much time. In Multi-Point function, **CANCEL** allows you to re-enter the point just entered, even if it was the last point needed to complete the function (unless you are in Forward Annotation). The **CANCEL** key also works in the Setup Mode; there it is used to cancel numbers or other entries.

PRESET OPERATION

You may want to establish an incremental or absolute datum offset from some datum without actually targeting the datum point. If so, follow these steps:



To preset the X axis display:

- If you are in **Edge**, cross the edge you wish to preset from. If you are in **Cross Hairs**, place the crosshairs over the point where you wish to start the preset.
- Press the **1/PRESET** key. "Axis to Preset?" is displayed in the message window.
- Press the **X** key. "X Pre" is displayed in the message window.
- If you wish to enter an absolute preset press the **INC/ABS** key so the indicator light goes out.
- Enter the number that you wish to preset (1.2 from the example), and press **ENTER**. The X axis display reads **1.2000**. The QC-2000 will start measuring from this new number. For example, if you target a point 1.5 inches to the right of the previously targeted point, the X display will read **2.7000**.

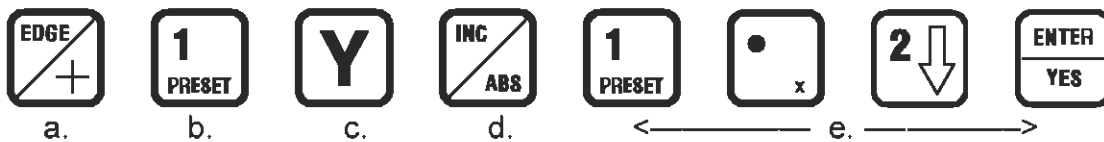

PRESET OPERATION (CONTD)

To preset the Y axis display, follow steps a. - e. and press the **Y** key instead of the **X** in step c. The Y axis display reads **1.2000**. The QC-2000 will now start measuring from this new number. If you target a point 0.3 inches above the previously targeted point, the Y display will read **1.5000**.

When you establish a new incremental or absolute origin point in either INC or ABS you are in effect telling the QC-2000 that the new origin is the preset distance away from the location displayed when you press the PRESET key.

Let's try a few examples. You are inspecting a detail that is a piece of a larger assembly. Your dimensions for this part are from a composite drawing and the absolute origin is 3 inches off the left edge of the detail. In order to have the displays read the same as the dimensions on the drawing you need to preset your absolute datum to compensate for it. For the purpose of this example we will only talk about the X axis. First make sure you are in the Absolute (**INC/ABS**, light off) and Crosshairs (**EDGE/+**, light off) Modes. Position the crosshairs over the left edge of the part and press the following keys in order:



You will see **3.0000** inches displayed in the X axis this is the dimension shown on our frammet assembly print. Now, as you measure the part you will have the correct offset added to your measurements.

For our next example we are inspecting a widget with a feature that is X **3.3300** inches and Y **3.6600** inches away from the lower left corner. When you measure this feature you would like to display the deviation from the dimension instead of the actual dimension. Suppose the feature on the widget is **3.3352**, **3.6623** and not what it is supposed to be (**3.3300**, **3.6600**). When you measure you want to see **0.0052**, **0.0023**. Make sure you are in Crosshairs Mode (**EDGE/+** light off), and position the crosshairs over the lower left corner, then press the following keys in order.



and



The displays now show **-3.3300**, **-3.6600**. When you move to the feature, the axes will display the deviation from the specified dimension.

PRESET SKEW

If you know what the angle of the skew is; press the **PRESET** key and the **SKEW** key then enter the angles value using the numeric keypad. When the angle is entered the LED above the **SKEW** key indicating that the skew is set.

CREATE FEATURES

You can create features for specific dimensions you want by using the following procedure.

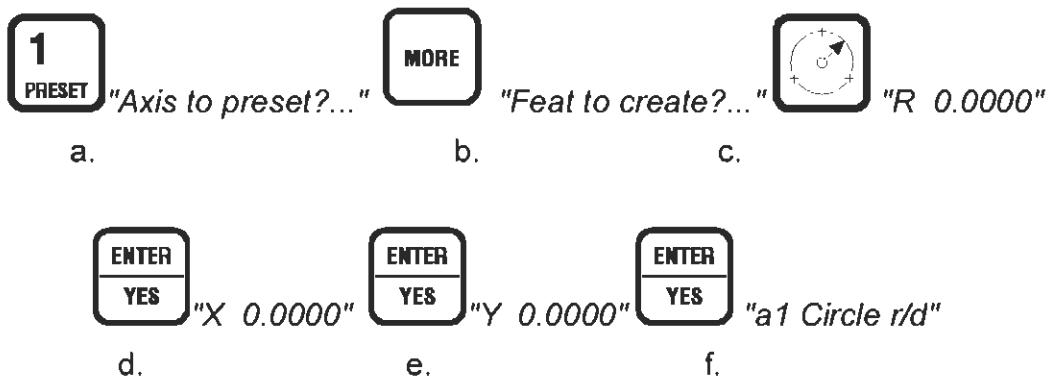

- a) Press the **PRESET** key.
"Axis to preset?..." is displayed in the message window.
- b) Press the **MORE** key.
"Feat to create?..." is displayed in the message window.
- c) Press the feature key, for this example press the **CIRCLE** key.
"R 0.0000" is displayed in the message window.
Enter the radius by using the numeric keypad.
- d) Press **ENTER**.
"X 0.0000" is displayed in the message window.
Enter the X axis by using the numeric keypad.
- e) Press **ENTER**.
"Y 0.0000" is displayed in the message window.
Enter the Y axis by using the numeric keypad.
- f) Press **ENTER**.
"a1 Circle r/d..." is displayed in the message window. The X display shows the radius that you entered. The Y display shows the diameter entered.

MULTI-POINT MEASUREMENTS

When you measure a circle, any three non-collinear points are sufficient to fully define that circle. So, when you use 50 points to define a circle, what happens to the other 47 points?

Every point is weighted equally and counts no more than any of the other points. The first three points are used to form a “guesstimation” of the circle.

In effect, the circle is “shifted” around until its circumference is as close to every point as it can be. Any further shifting to better accommodate a few points would lead to greater distances from other points.

One reason for using more than the mathematically-needed 3 points to measure a circle is to average out unavoidable inconsistency. Using three points to measure a circle means that each point contributes approximately 33% to the answer; using 50 points gives each point, on average, a 2% weight. Any single stray point will not severely change the measurement of the circle as a whole.

Similarly, a part with rough edges would be difficult to measure accurately without the QC-2000's multi-point capabilities. When more than 3 points are used a rough edge can be measured with greater repeatability.

This entire discussion can be applied equally to all multi-point features. Pictured on the next pages are illustrations of the multi-point features: angles, circles, and lines . (Although, to be precise, angles are relations, not features.)

The quantization error that exists in all geometric measuring systems also exists in the QC-2000 digital readout system. A small arc less than 90 degrees may cause a repeatability problem (similar to measuring a small arc on an overlay screen versus measuring a complete circle). An arc less than 30 degrees may cause serious repeatability problems. The very short legs of angles may also induce an error factor into the system calculation capability. (When using the Electronic Protractor Option, magnification of the small angle will help to resolve the angle quantization error to one minute.)

Reference

ABOUT MULTI-POINT MEASUREMENTS (CONTD)

The following chart shows the mathematical effects of the number of points taken on a circle with a radius of .250" and .00008" (2 Micron) resolution scales. (This chart assumes no system error). As you can see the average error above 90° arc is the scale resolution and the repeatability of the calculation is +/- 1 count of the scale.

Circle Radius = .250" Encoder Resolution = .00008" (2 Micron)

	<u>Degrees of Arc Segment</u>							
	<u>10°</u>		<u>30°</u>		<u>45°</u>		<u>60°</u>	
	Mean	Max	Mean	Max	Mean	Max	Mean	Max
3	.0060	.0186	.0007	.0020	.0003	.0009	.0002	.0006
4	.0053	.0174	.0006	.0018	.0002	.0008	.0002	.0004
10	.0041	.0143	.0005	.0017	.0002	.0007	.0001	.0004
15	.0035	.0126	.0004	.0015	.0002	.0006	.0001	.0004
20	.0032	.0107	.0004	.0013	.0002	.0006	.0001	.0003
30	.0027	.0108	.0003	.0010	.0002	.0005	.0001	.0003

	<u>90°</u>		<u>120°</u>		<u>180°</u>	
	Mean	Max	Mean	Max	Mean	Max
	3	.0001	.0003	.0001	.0002	.0000
4	.0001	.0002	.0001	.0002	.0000	.0001
7	.0001	.0002	.0001	.0002	.0000	.0001
10	.0001	.0002	.0001	.0002	.0000	.0001
15	.0001	.0002	.0001	.0001	.0000	.0001
20	.0001	.0002	.0001	.0001	.0000	.0001
30	.0001	.0002	.0000	.0001	.0000	.0001

Unless shown differently, the numbers in this chart are shown to the nearest .0001" because of Metric scale resolution.

Mean = The average true position of the calculated circles center for 0,0.

MAX = The total repeatability error that can be expected from the calculated circles center.

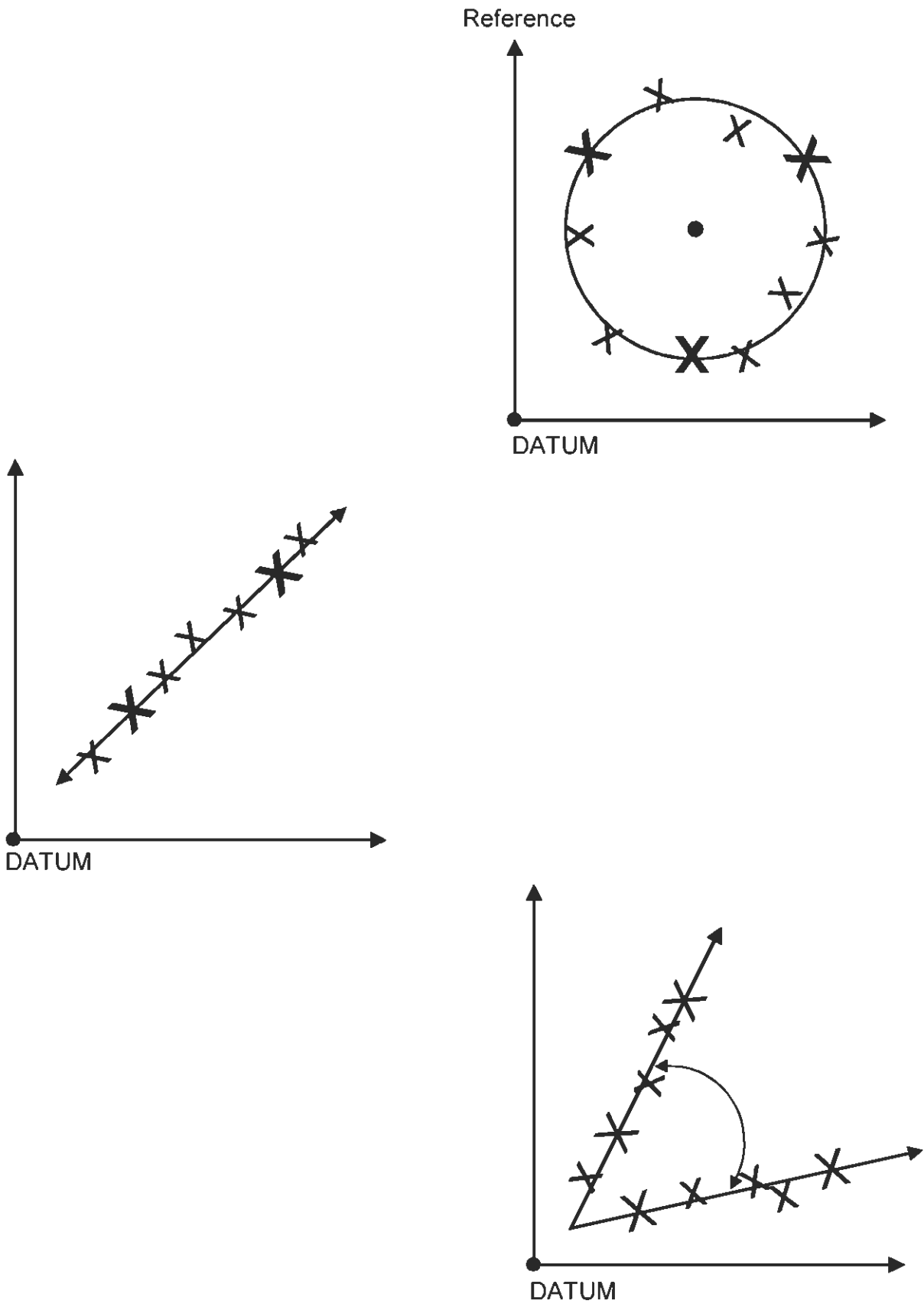

Fig. 4-1 Multipoint Measurements.

MEASURE MAGIC

What is Measure Magic? -- This function automatically creates the correct geometric features simply by entering points. Of course, there are some simple rules and probing techniques to follow, but measuring a part will become so fast and easy you'll probably want to use it most of the time.

Before You Begin

Before initiating the Measure Magic function, the user must decide if *RELATIONS* are going to be included in the session.

If Relations is off (**Relations: No**), Measure Magic will not generate any Distances or Angles. When it is on, a 2 point line will be generated as a Distance, and Angles will now be generated if probing technique is correct. (See *Probing Techniques*)

When you receive your QC-2000 "**Relations**" is factory set at **Yes**. To turn Relations off, perform the following instructions. To include relations when using Measure Magic, you **must** turn on "**Relations**" (**Relations: Yes**) under the *Supervisor Menu*.

PROBING TECHNIQUES

As mentioned above, there are some rules and probing techniques that you must follow for Measure Magic to work accurately. Following these simple probing techniques, will allow the Measure Magic function to work at its fullest potential..

Point Measurement

To measure a point enter **ONE** point and press **FINISH**.

Distance Measurement

To measure a distance (slot width etc.) Probe **TWO** points, then press **FINISH**.

Note: Relations must be on (Yes) to calculate a distance - otherwise, a line will be calculated with two probed points.

Line Measurement

To measure a line, probe **THREE** or more points on the line, then press **FINISH**.

Circle Measurement

To measure circle, probe at least **THREE** points on the circle then press **FINISH**. There must be at least **185 degrees of arc** from the first to the last probed point.

Note: *Although 3 points are sufficient to measure a circle, it is good practice to probe at least 4 points equally spaced around the circle. This will insure accurate circle measurement.*

MEASURE MAGIC (CONTD)

Angle Measurement

To measure an angle, take a minimum of **THREE** points and an **equal number of points on each leg of the angle** then press **FINISH**.

Note: *Angles and Distances will only be generated if "Relations" is initiated and probing techniques are correct.*

Using Measure Magic

Measure Magic operates in two different modes.

1. **Singular Mode** - You will be able to probe points on one feature, and Measure Magic will calculate information on that one feature. Measure Magic will then deactivate and you can now select any other measurement function.
2. **Auto Repeat Mode** - Allows you to probe an unlimited number of features (pressing FINISH after each feature) until you choose to deactivate Measure Magic by pressing the CANCEL/NO key. With Measure Magic in the *Auto Repeat Mode*, just probe features then press the FINISH button or footswitch and see your productivity soar. Measure Magic lets you push the work, not the buttons.

Singular Mode Measure Magic

"Enter Setup?"

a.



"Clear"

b.



"Measure Magic?"

c.



"Probe Feature"

d.



"Finish"

e.

- a. Press the **SETUP (5)** key on the QC-2000's Numeric Keypad. "Enter Setup?" appears in the message window.
- b. Press **ENTER** . "Clear" appears in the message window.
- c. Press the **DOWN ARROW** once. "Measure Magic?" appears in the message window.
- d. Press **ENTER**. "Probe Feature" appears in the message window and the 5 measurement function keys will be lit. **Note:** *DIST* and *ANGLE* will only light if *Relations:Yes* is selected.
- e. Now probe points on any geometric feature pressing the **FINISH** button after completing the measurement.

MEASURE MAGIC (CONTD)

Auto Repeat Mode

In this mode, the QC-2000 can be utilized in two different ways. The first of course is the regular Auto Repeat Mode; allowing several features to be measured without repeatedly pressing a measurement function key.

To turn on the Auto Repeat Mode:

- Follow steps a. through d. as above.
- Once in Measure Magic, simply press any one of the lit function keys.

In most cases, operators will be using the Measure Magic function because they have quite a few features to measure. This also means they will probably want to **STORE** the features. By pressing the **STORE** key instead of a lit measurement function key, the Auto Repeat will become **Auto Repeat/Auto Store**.

In this mode, the features will automatically be stored in permanent memory and will be accessible by selecting the **RECALL** key and entering the appropriate 2 digit number.

SKEW ON TWO CIRCLES CENTERS

The **RECALL** function allows you to use stored features as data points for any Multi-Point function, in addition to its uses as described in "Memory Operation" .

Suppose you need to skew align a part that has no vertical or horizontal sides, but instead has two circles whose centers define a vertical or horizontal datum line. To skew on those two points, follow these steps:

- a. Place the part on the stage with the two alignment holes approximately aligned with the axis they represent. For example, if the X axis runs through the holes then place the part with the two holes nearly horizontal.
- b. Do a Circle calculation on one of the holes. Then store it as a permanent feature. For example, use memory location 04, press **STORE**, **04** and **ENTER**.
- c. Do a Circle calculation on the other hole, and store it in location 05.
- d. Press the **SKEW**.
- e. Press **RECALL 04**, **ENTER**.
- f. Press **RECALL 05**, **ENTER**. You have aligned the part with the reference axis traveling through the centers of the two holes.
- g. Press **FINISH**.

BOLT CIRCLE CALCULATION

Calculate the bolt circle diameter by using auto edge and the following procedure. Use the circle function to find the centers of three or more bolt holes in the bolt circle, targeting between 3 and 50 points on the circles circumference. Store each center as a different feature.

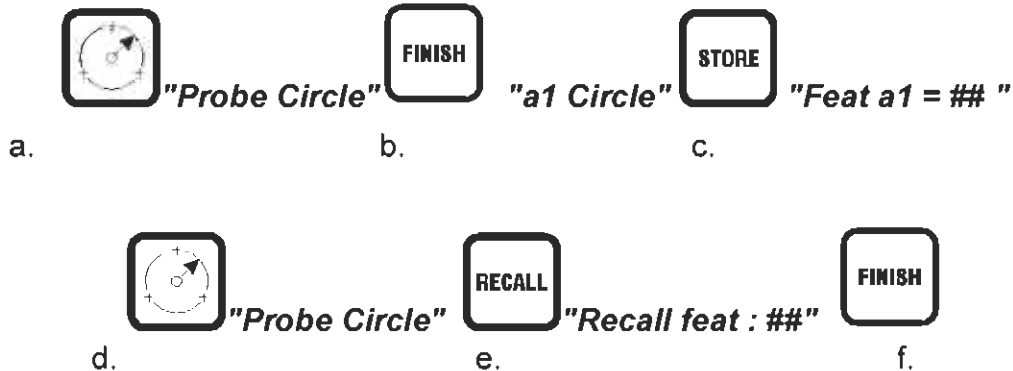

- a. Press the **CIRCLE** key.

"Probe Circle" will appear in the message window.
Target the desired number of points.

- b. Press **FINISH**.

"a1 Circle" is displayed in the message window. The circle data has been stored as a temporary feature.

- c. Press **STORE**.

"Feat a1 = ## " is displayed in the message window. The circle data is stored as a permanent feature. Remember the permanent feature number.

Repeat steps a. through c. for each circle you are going to use.

- d. Press the **CIRCLE** key.

"Probe Circle" will appear in the message window.

- e. Press **RECALL**.

"Recall feat : ##" is displayed in the message window.

Enter the permanent feature number. Repeat the procedure for the remaining circles

- f. Press **FINISH**, the bolt circle feature will be displayed in the message window.

Up to 50 circles can be used for this type of construction by storing the circles and then recalling each circle when required.

MIN/MAX RADIUS FUNCTION

The Min/Max feature is used to perform a shaft checking function, i.e. a "Min/Max" target function. The QC-2000 continuously monitors the probe position until **FINISH** is pressed. Once pressed, the Min/Max information is placed on the temporary feature list as "a1 MinMax Rg". Pressing the **MORE** key will display "a1 Minmax -+Y". These can be stored in permanent storage the same way as any other feature.

To initiate the MinMax function:



"Enter Setup?"

a.



"Clear"

b.



"MinMax?"

c.



"MinMax X/Y"

d.

- Press the **SETUP (5)** key on the QC-2000's Numeric Keypad. "Enter Setup?" appears in the message window.
- Press **ENTER** . "Clear" appears in the message window.
- Press the **DOWN ARROW** until "MinMax?" appears in the message window.
- Press **ENTER**. "MinMax X/Y" appears in the message window.

There are 3 different Min/Max displays in which you can view while measuring.

Display 1:

X display:	Current or Last Edge X position
Y display:	Current or Last Edge Y position
Message Window	"MinMax X/Y"

Display 2:

X display:	Blank
Y display:	The range of Y since the start of the function (MaxY - MinY).
Message Window	"MinMax Rg"

Display 3:

X display:	Minimum Y values since the start of the function.
Y display:	Maximum Y values since the start of the function.
Message Window	"MinMax Min/Max"

Reference

MIN/MAX RADIUS FUNCTION (CONTD)

- Pressing **MORE** toggles between the above displays.
 - Pressing **CANCEL** sets the Min and Max to the current values of Y
 - Pressing **FINISH** causes the Min and Max to be stored as a feature and return to setup.
 - Pressing **QUIT** aborts the Min/Max mode and return to setup.
-
- Once **FINISH** is pressed, the MinMax data is display as follows:

Display 1:

X display: Blank
 Y display: The range of Y (MaxY - MinY).
 Message Window "a1 MinMax Rg"

- Pressing the **MORE** key will display the 2nd display:

Display 2:

X display: Minimum Y.
 Y display: Maximum Y.
 Message Window "a1 MinMax -+Y"

These features are not a valid input to any construction. They can be printed out on a 32, 40, or 80 column printer by pressing the **PRINT** key while they are in the display. Sample printouts are as shown.

32 Column Printout

```
00 MinMax
Rg 0.0035 in
Mn 1.0025 in
Mx 1.0060 in
```

40 Column Printout

No.	FEATURE	ID	Dimension
001	MinMax A DMS in Abs	00	Rg = 0.0035 Mn = 1.0025 Mx = 1.0060

80 Column Printout

No.	FEATURE	ID	Units	Position	Dimension	Form
001	MinMax A DMS in Abs	00	Inch A DMS		Rg = 0.0035 Mn = 1.0025 Mx = 1.0060	

SETUP MENU

The Setup menu contains a variety of items, all of which you will find useful. It is primarily used to establish various set up parameters of the QC-2000. It is also used to edit programs, set up remote keypads and select your printout features.

This menu is Hierarchical. This means pressing the Setup key, will bring you to the first menu item. You will notice the (?) question mark next to the item, and needs a YES/NO answer. To move into the Hierarchy press **ENTER/YES**. To move up or down the Hierarchy press the **UP** or **DOWN** arrows.

Whenever you see up and down arrows in the message display window, it means that there are more items you can view in the menu. Use the **UP** and **DOWN** keys on the numeric keyboard to scroll through the menu items.

Certain items contain a selection choice. A check mark (√) next to the word, indicates the current selection. Press **ENTER/YES** to change selection, then **FINISH** to return to the main menu. Pressing **QUIT** twice, will bring you back to *CURRENT POSITION*

The following information will walk you through the menu items and give a brief description of there use.

Clear?

The "Clear..." menu entry is used to delete or retain all the features in the QC-2000 system memory. Pressing **ENTER** in response to Clear will display "*Clear all feats*" in the message window. Pressing **ENTER/YES** in response to "*Clear all feats*" will delete the features. Pressing **CANCEL/NO** will retain all the features in the system memory.

Pressing the **DOWN ARROW** in the Clear menu will display "*Clr Errors?*" in the message window. Pressing **ENTER/YES** in response to "*Clr Errors?*" will delete the errors. Pressing **CANCEL/NO** will retain all the errors in the system memory.

Pressing the **DOWN ARROW** again will display "*Clr Programs?*" in the message window. Pressing **ENTER/YES** in response to "*Clr Programs?*" will delete the programs. Pressing **CANCEL/NO** will retain all the programs in the system memory.

Pressing the **DOWN ARROW** again will display "*Clr Remote?*" in the message window. Pressing **ENTER/YES** in response to "*Clr Remote?*" will delete the remote keypad features. Pressing **CANCEL/NO** will retain all the remote features in the system memory.

Pressing the **DOWN ARROW** again will display "*Unskew?*" in the message window. Pressing **ENTER/YES** in response to "*Unskew?*" will unskew the present skew. Pressing **CANCEL/NO** will retain the current skew.

Measure Magic?

Pressing **ENTER/YES** in response to "*Measure Magic?*" will initiate this function.

SETUP MENU (CONTD)

MinMax?

Pressing **ENTER/YES** in response to "*MinMax?*" will initiate this function.

Angle Type...

Pressing **MORE** or **ENTER/YES** to "*Angle Type...*" will allow the user to choose between DMS or DD angle type. Press **ENTER/YES** to choose.

Remote Keys...

Pressing **MORE** and using the down arrow, will allow the setup of the remote key or foot switch, as well as programming to the front panel keys. (See *Option Section*).

Annotation...

Pressing **MORE** allow the user to choose *Forward or Backward annotation*.

Set Default?

Pressing **ENTER/YES** will set Inch/MM, Cart/Pol and other selected items as the default.

Print all Feats

Press **ENTER/YES** will automatically send all features (including temporary) to a printer or computer via RS-232 port.

Print Programs...

Press **MORE** to select:

Print One? - Press **ENTER** and the program you wish to print.

Print All? - Press **ENTER** to print all programs.

Feature Format...

Pressing the **MORE** key and using the down arrow will allow the user to select:

Set Number - Choose which feature ID number will begin the printout.

Printer type (32,40,80 column),

Form Feed - **YES/NO**.

Define Header - Press **ENTER/YES** to view alphabet. Use the **UP** and **DOWN** arrows to move letters 6 at a time. Use the **4** and **6** keys to move the flashing letters one at a time.

Press **ENTER** select the flashing letter.

RS232...

Pressing the **MORE** key and using the down arrow will allow the user to set all communication parameters such as:

Baud Rate - From 19200 baud to 50 baud. (Note: 19200 is not recommended for use)

Parity - NO Parity, ODD Parity or EVEN Parity.

Stop Bits- 2, 1.5, or 1 stopbits.

Data Bits - 8,7,6 or 5 data bits.

Protocol - HARDWARE for printers, XON/XOFF for computers.

Preline - Enter an ASCII command for before a line is printed. (see ASCII table).

Postline - Enter an ASCII command for after a line is printed. (see ASCII table).

Preform - Enter an ASCII command for before a page is printed. (see ASCII table).

Postform - Enter an ASCII command for after a page is printed. (see ASCII table).

DP3 NO - Pressing **YES** overrides all other RS232 settings

POE - PRINT ON EDGE is used to print on an edge crossing. To change the POE setting, enter the setup menu and arrow down to the RS232 entry. Press the **ENTER** key and arrow down to the POE heading. The menu item will read "*POE: No*". If you do not want to print on an edge crossing press the **NO** key. If you want to print on an edge crossing press the **YES** key.

Print Settings

Pressing **ENTER/YES** will automatically send QC-2000 parameters to printer or computer via the RS232 port.

Test QC-2000

The test menu allows you to perform certain hardware tests on the QC-2000 system. The TEST sub menu consists of six entries: Test Axis, Test Keys, Test IO, Test Memory, Test Remote and Test Display. If any of these tests should fail, please contact your original QC-2000 dealer. We must emphasize that all these tests perform only hardware tests and do not test cabling. Pressing **QUIT** will return you to the beginning of the test sub menu..

1. **Test Axis** - Press the **ENTER** key to start the test. The message "No axis error" appears in the message window at the successful completion of the test. Press the **FINISH** key to exit the axis test and go on to the next test.
2. **Test Keys** - Press the **ENTER** key to start the test. The message "*Test Keys...*" appears in the message window. You must press every key on the front panel, starting with the top left key, moving from left to right, down and across every row. Each keypress will display the key name in the message window. When the key testing is successfully completed you will be returned to the menu.
3. **Test I/O** - The QC-2000 is fixtured with a RS-232 serial port and a keyboard/keypad input jack. With "*Test I O*" appearing in the message window, press the **ENTER** key to begin the test. The message "*Testing I O*".. appears in the message window and at the successful completion of the test, the message "*I O test passed*" is displayed. Press the **FINISH** key to exit the I/O test and go on to the next test.

SETUP MENU (CONTD)

4. **Test Memory** - Pressing the ENTER key will instruct the QC-2000 to perform a non-destructive test to check the memory addresses and the binary addition (sum) of the bits of both the RAM (Random Access Memory) and ROM (Read Only Memory). Press the **ENTER** key to begin the test. After the test is performed the message "RAM test passed" will be displayed in the window. Press any key to continue. After the test is performed the message "ROM test passed" will be displayed in the window. Press the **FINISH** key to exit the memory test and go to the next.
5. **Test Remote** - Press the **ENTER** key to start the test. The message "Begin testing..." appears in the message window. Press all the keys on the Remote Keypad in succession. When the 8 keys have been pressed, press the **FINISH** key to exit the test and go to the next.
6. **Test Display** - This test is designed to check each LED on the front of the QC-2000. When "Test Display" appears in the message window, press the **ENTER** key to begin. You must press the **FINISH** key after each test phase is shown in the message window and check to see that the LED is on. When the test is completed the system will return to the Setup menu.

Display Resolutions

Display Resolution is automatically set when using the *Auto Setup* feature under Supervisor Setup (See Supervisor Setup Section). This menu selection allows the user to manually enter a specific resolution. There are eight (8) digits in the QC-2000 display (seven 0's and a minus sign). For inch resolution ranges from 0.1000 to 0.000001 inch and metric ranges, from 0.1000 to 0.00001mm. Angular display resolution is from 1.00 to 0.0001 degree.

To select the Display Resolutions, enter the setup menu and arrow down to the Display Resolutions heading. Press **ENTER** to enter the sub menu, arrow down to the specific resolution you are going to use and press the **ENTER** key to select it. Press **FINISH** to complete the entry and exit the sub menu.

- | | |
|-----------------------------------|---|
| <i>MM Display Resolution</i> - | When "MM disp res" shows in the message window press the ENTER key. "MM: 0.00000" use the numeric keypad to input the changes, then press FINISH . |
| <i>Inch Display Resolution</i> - | When "Inch disp res" shows in the message window press the ENTER key. "Inch: 0.000000" use the numeric keypad to input the changes, then press FINISH . |
| <i>Angle Display Resolution</i> - | When "Angle disp res" shows in the message window press the ENTER key. "MM: 0.00.00" use the numeric keypad to input the changes. Press FINISH to select the entry and exit the sub menu. |

SETUP MENU (CONTD)

Default Units

Press **ENTER** and use the **DOWN** arrow to default the QC-2000 to *INCHES* or *MILLIMETER*.

Flash Delay

Press **ENTER** and use the numeric keypad to the amount of seconds messages will stay in the alpha-numeric window. Numbers range from 1 to 9.

Axis Direction

Press **ENTER** and use the **DOWN** arrow to reverse axis count direction.

Super

Press **ENTER**, enter the password and use the **DOWN** arrow key to set the QC-2000's *Encoder Resolution*, enter *Correction* factors and perform other calibrations needed. Please refer to the **Supervisor Section** for more information. (Note: These menu items are intended for your dealer or supervisory personnel. Your QC-2000 should be already set up and calibrated. Please contact your dealer for more information or help).

Languages

The languages currently available to implement are English, French, German, Spanish and Italian. Any of the offered languages may be selected as a default language, which is indicated by a check mark before the language entry. To select the language, enter the setup menu and arrow down to the Language heading. Press **ENTER** to enter the sub menu, arrow down to the language you are going to use and press the **ENTER** to select the language. When the selection is made the QC-2000 will automatically exit to the "Current Position" screen.

EDIT CAL

The Edit Cal function allows a user to keep a large set of Edge Detector calibrations for several different light levels or magnifications, making it unnecessary to repeat the AUTO CAL function each time light levels or magnification changes.

To send Edit Cal values to the QC2000:

"RECEIVE EDGE CAL #0 #1 #2 #3 #4 #5 #6"

Where #0.....#6 are whole numbers corresponding to Edit Cal values. If all seven numbers are understood by the QC2000, a reply of "SUCCESSFUL", otherwise "UNSUCCESSFUL", will be received.

To receive Edit Cal values from the QC2000:

"SEND EDGE CAL"

Which causes a reply of the Form: "#0 #1 #2 #3 #4 #5 #6" where #0....#6 are as defined above.

Reference

NOTE: In all references to RS232 commands or transmitted data, the double quotes should not be sent or received. All such transactions should be followed by a carriage return.

ERROR MESSAGES

The message display flashes when an error has been determined by the QC-2000. The following is a list of error messages:

Incorrect Key

You have pressed a key which has no valid meaning in the present context.

No Construction

You have instructed the QC-2000 to construct a feature from an incorrect or incomplete assortment of components. Example: you cannot construct a circle from 2 points, a line and a distance, or a circle and line; they do not intersect and you will get the same error message.

Out Of Range

This message is displayed when either a feature or number generated by the calculator is too large to be displayed. Example: trying to construct the intersection point of two nearly parallel lines.

No More Pts

This message is displayed when you try to include more than 50 points or features in a construction or a feature measurement.

Program Locked

This is a reminder that you cannot delete, edit or print any program that has been locked. Programs may be locked and unlocked using the LOCK Soft Key in Supervisor Set Up.

Wait RS-232 Port

This message appears when RS-232 Port is unable to communicate with the device attached to it. Check the settings for each peripheral to make sure they match the appropriate RS232 port (see RS-232 Serial Port Pin Out).

No Intersection

No Intersection between lines or line/circle points.

Axis Blinking

The counter is misreading the X and/or Y axes scale. This may be caused by over slewing or dirt on the on the scales. Press any key to exit the condition; the QC-2000 will return to its initial status with both absolute and incremental datum's zeroed.

REFERENCE GLOSSARY

Absolute Datum	The Absolute Datum is the datum point from which all other measurements are made.
Auto Mode	A targeting mode in which points are automatically confirmed when targeted. Auto Mode is used most often with touch probes and the Optical Edge Detector. <i>See Manual Mode.</i>
Axes	The plural of axis.
Axis	A single direction of motion, usually signified by the letters X and Y. X represents horizontal position and Y represents vertical position. <i>See Q Axis.</i>
Best-Fit	This process is known as "Best-Fit" because it best fits all the targeted points. Additional target points beyond the minimum help average out any inconsistency and error providing a result that lies closest to all the individual points.
Character	A single letter, number, or special character.
Collinear Points	Points which all lie on the same line.
Constructing Features	Combining previously generated features such as using 3 circles to construct a Bolt Hole Circle.
Creating Features	You create features by "filling in the blanks." When you create a circle, for example, you need to enter the circle's center location and radius.
Datum	A portion of data necessary to define a reference frame. Datums may be points (Incremental or Absolute Datum), or lines (axis), (2 axes to define an X-Y coordinate system).
Electronic Protractor	<i>See Q Axis.</i>
Ellipsis	When three periods are seen at the end of a prompt in the message window (e.g. Record program?...) it indicates additional information may be viewed by pressing the MORE key
Execute	To cause the QC-2000 to act upon the steps contained within a program.

Reference

Feature	A basic geometric shape the QC-2000 can measure (point, line, circle). When completed, the new feature is placed as a1 in the Feature List.
Feature List	The list of features displayed in memories. Pressing the UP ARROW or DOWN ARROW keys when in the DRO mode (Current Position or Last Edge Crossed are displayed) will scroll through the current list of features and their locations.
Feature Name	The identifying label attached to each feature. Temporary features are labeled with alphanumeric tags - "a2". Permanent features are labeled with pure numeric tags - "10".
Feature Type	Every feature generated belongs to a specific Feature Type. All circles are "Circle" types, points are "Point" types etc. This is a convenient way to categorize features.
Form Data	Information associated with a feature which reveals, from among all the points used to construct the feature, how aberrant the worst points were. Form information is shown in the alpha display message window.
Incremental Datum	The datum point from which all incremental measurements are made. <i>See Absolute Datum.</i>
Leg	One of the two lines which make up an angle.
List Mode	The method by which the Feature List is displayed. It is used when constructing features.
Magnitude	Angle magnitude means the size of the angle between 0° and 360°. When referring to a line segment it means the length of the segment.
Measure Magic	A function that will automatically create the correct geometric features by following certain probing techniques when entering points .
Measuring Machine	A description of comparators, microscope stages, etc.
Menu	The list of choices displayed in the message window.
Name	<i>See Feature Name or Program Name.</i>

Reference

NLEC	Non-Linear Error Correction (NLEC) is a program that automatically corrects for most non-linear measurement errors. Vibration or differential expansion error is not corrected by this program.
Origin	<i>See Absolute Datum or Incremental Datum.</i>
Permanent Feature	A Feature that is retained by the QC-2000 until it is overwritten.
Probing A Feature	The process of providing the QC-2000 with sufficient target points to form a mathematical model of the physical one.
Program	<i>See User Program.</i>
Program Step	A keypress within a User Program.
Q Axis	The optional 3rd axis in the QC 2000 which may be defined as either a linear or rotation display. This axis is used for display purposes only and is not a part of the feature reference frame. See Options.
Reference Frame	All the information necessary to define a measuring area including Absolute Datum, Incremental Datum, and orientation of the axes.
Reference Mark Calibration	A procedure is to teach the QC-2000 the width of the reference mark in the linear encoder. This will insure compensation for the width in either direction of reference.
Relation	Angles and distances are relations. A relation is the result of a construction involving two features. (e.g. An angle relation is constructed from two lines.)
Run Program	See Execute. Refer to programming section for more details
Scales	The electro-optical devices used to determine the position of a probe or measuring device.
Set Up	The process of providing primary information to the QC-2000, such as the type of units you are using and settings like RS-232 protocol.
Skew Alignment	Electronically aligning a part to indicate the rotation of the part's axes relative to the measuring machine's axes.

Reference

SLEC	Segmented Linear Error Correction - A software function which will automatically correct for most small non-linear errors that may occur in portions of the axes.
Step	<i>See Program Step.</i>
Temporary Feature	A feature which was generated but never given a numeric tag. Temporary Features are not lost when the QC-2000 is turned off, but can be replaced by other Temporary Features as they are generated.
Toggle (Noun)	A switch that has only two possible positions - the display mode must be either MM or IN.
Toggle (Verb)	The act of changing values such as switching between MM and IN modes by pressing the MM/IN key.
User Program	A sequence of user created instructions to be executed on command by the QC-2000 .
Vertex	The point at which the two legs (rays) of an angle intersect.
Word Length	The number of bits an RS-232 port will accept as a group. This number is usually 7 bits (ASCII code) or 8 bits (byte length).

QUADRA-CHEK 2000

SECTION V COMMUNICATION

COMMUNICATIONS

QC-2000 <----->PRINTER

This section explains how to interface between a printer and a QC-2000. There are many manufacturers of printers. Unfortunately they are not all compatible, and it would be impossible to support every one of them. It is the users responsibility to check compatibility , cabling and system configuration accordingly.

The most **important information** you should know when purchasing a printer for use with a Quadra-Chek, is that it *must* be a **SERIAL PRINTER!**

SETTING THE RS-232 PORT

In order for your QC-2000 to communicate with you printer or computer, the RS-232 must be set properly. The following is a list of factory default settings:

Baud Rate	4800	
Parity	No Parity	
Stop Bits	2	
Data Bits	8	
Protocol	Xon/Xoff (Computer)	Hardware (Printer)

Follow the procedure below to change default settings.

1. Press the 5 key (Setup), then press **ENTER**
2. Using the 2 key (Down arrow), scroll down until **RS232** appears.
3. Press **ENTER**. "*Baud*" now appears.
4. Press **ENTER** and scroll down until the baud rate you wish to choose appears in the window.
5. Press **ENTER** then **FINISH**. "*Baud*" now reappears in the window.

Repeat steps 1 thru 5 to change the other RS232 settings.

SERIAL PORT RS-232 PIN OUT

<u>Pin No.</u>	<u>Description</u>	<u>Direction</u>
2	Data In	Input
3	Data Out	Output
5	Handshake Out	Output
6	Handshake Out	Output
7	Signal GND	Common
8	Power On	Output (always high)

Communication

20 Handshake In Input

HANDSHAKE DESCRIPTION

Pin 20 must be high voltage for the serial port to transmit.

Pins 5, 6 will go low voltage when input buffer is full. If sender does not stop transmitting when 5 or 6 is low, data transmitted to the serial port will be lost.

Refer to the following diagram when making or checking a cable.

IBM 9 PIN	IBM 25 PIN	RS232	QC 25 PIN	PRINTER
1	8	DCD		
2	3	RX	3	3
3	2	TX	2	
4	20	DTR	20	11
5	7	GND	7	7
6	6	DSR	6	
7	4	RTS	4	20
8	5	CTS	5	
9	22	RI		
5	1	GND	1	1

Use the following data to set up a QC-2000 for operation with a printer or computer using the programs found in the manual:

SET UP

Feature Format

- Set Number -* Select number from 0 to 999.
- Column -* Choose from 32,40 or 80 column printer.
- Form Feed: -* Select YES if you wish your printer to Form Feed.
- Define Header -* Enter information for heading.

RS232

- Baud* 4800 BAUD
- Parity* NO PARITY
- Stop Bits* 2 STOP BITS
- Data Bits* 8 DATA BITS
- Protocol* Hardware (Printer) Xon/Xoff (Computer)
- Pre Line* Select Control Character. (See Glossary for more information).
- Post Line* Select Control Character. (See Glossary for more information).
- Pre Form* Select Control Character. (See Glossary for more information).
- Post Form* Select Control Character. (See Glossary for more information).
- DP3:* MTI's 10 pin BCD format

Communication

POE: If Yes, will print on Edge Crossing

FEATURE PRINT FORMATS

In the following, the "v" means to ignore the character it is substituted for i.e., X, Y, Z, r, d, <, T, R, A, etc.

"d" means digit
 "-" is the negative sign
 "s" means space
 "c" means carriage return

For positive outputs, the space character will be substituted for the negative sign "-". The leading digits may be spaces (see the examples).

When a QC-2000 is shipped from the Metronics factory each output line is terminated by a carriage return (13).

The Angle format is:

In DMS notation, with the factory default display resolution (which is full degrees, minutes, and seconds) the printout is as follows:

Character																			
Position:	1	2	3	4	5	6	7	8	9	0	1	2	3	4	5	6	7	8	9
Content:	v	v	s	-	d	d	d	.	d	d	.	d	.	s	s	s	s	s	c
Example 1:	<	1					4	5	.	0	0	.	0	1					
Example 2:	A						-	5	.	2	3	.	0	0					

For Decimal Degrees the format is:

Character																			
Position:	1	2	3	4	5	6	7	8	9	0	1	2	3	4	5	6	7	8	9
Content:	v	v	s	s	-	d	d	d	.	d	d	d	s	s	s	s	s	s	c
Example 1:	<	1						4	5	.	0	0	1						
Example 2:	A						-	5	.	3	0	3							

The Linear dimensions:

Note that the units (in or mm) are always at position 15 and 16.
 The factory default Metric resolution is 1 micron.
 The factory default English resolution is 0.0001 inch.

For Metric values with a display resolution of 1 micron, the format is:

Character																			
Position:	1	2	3	4	5	6	7	8	9	0	1	2	3	4	5	6	7	8	9
Content:	v	s	s	-	d	d	d	d	.	d	d	d	s	s	m	m	s	s	c
Example 1:	r					3	2	4	.	0	5	1			m	m			
Example 2:	x						-	5	.	3	0	3			m	m			

For English values with a display resolution of .0001 inch, the format is:

Character																			
Position:	1	2	3	4	5	6	7	8	9	0	1	2	3	4	5	6	7	8	9
Content:	v	s	s	-	d	d	d	.	d	d	d	d	s	s	i	n	s	s	c
Example 1:	r						2	.	0	2	1	3			i	n			
Example 2:	x				-	1	5	.	1	4	4	2			i	n			

FEATURE FORMAT

The QC-2000 is able to print features in one of three different formats depending on the selection made in the Set Up menu. Press the **SET UP** key, then the **DOWN ARROW** key until "Feature Format" is displayed in the message window. Press the **ENTER** key, then select the appropriate menu item that you wish to use i.e., *Set Number?*, *32 Column*, *40 Column*, *80 Column*, *Form Feed: No*, *Define Header?*

Set Number - is used to set the sequence value in the left column of the printout.

32,40 or 80 Column - The column format is used to select the appropriate column width for the printer attached to your system. The *32 column* format is designed for 32 column printers only. The *40 column* and *80 column* modes are used with the 40 and 80 column printers. See the following examples of these options.

Form Feed - is used to select the type of printer paper feed that is used (sheet feed or form feed).

Define Header - is used to complete the applicable information in the column heading.

ASSIGNING A CUSTOM HEADER

A custom Header can be defined for feature printouts using a 40 or 80 column printer. It will print the header whenever the feature number is equal to one or at the beginning of each page when form feeds are used.

Defining a custom header for feature printouts from the QC-2000 using a 40 column printer:

1. Enter the setup mode by pressing the "5" key then **ENTER**.
2. Scroll down to "Feature Format" and press **ENTER**.
"Set Number" will be displayed. Press **ENTER**.
"Value: # "is now displayed. Press "1" then **ENTER** to set the feature print to 1.
3. Scroll down to "40 column" and press **ENTER** to choose a 40 column printout.
4. Scroll down to "FORM FEED" and Press "**YES**" to print a new header for each page or skip this step if a new header is not needed.
5. Scroll down to "DEFINE HEADER?" and press **ENTER** to define or change the header.
6. To define the header scroll through the choices of characters using the "4" key to scroll left, the "6" key to scroll right, "ARROW UP" to move 6 characters at a time to the left and "ARROW DOWN" to move 6 characters to the right. Move left or right until the characters you want to enter is flashing and press **ENTER**.

NOTE: A blank space is to the left of the "!" character and does not flash. Continue entering characters until you have defined the header you wish to printout in the feature print. Press **FINISH**.

NOTE: A 40 column printer will except 38 characters.

To reset the feature number follow steps 1 and 2 above or you can write a program to do this and assign it to a front panel key. Refer to the user program section to create a program to reset the feature number to "1".. Run the program and check to make sure it changes the feature number.

PRINT ALL FEATURES

This function can be found in the *Setup* menu (5 key). Selecting this will send all features, (including temporary features) to a printer or computer via the RS232 port. All features will be printed from lowest to highest.

To Select Print All features:

1. Press the *Setup* key (5). "*Enter Setup*" appears in the window.
2. Press **ENTER**; "*Clear*" will appear in the window.
3. Press the **DOWN ARROW** key until "*Print All feats*" appears in the window.
4. Press **ENTER**; all features will be sent via the RS232 port.

Communication

32 Column Example:

```
Id: 00 point
X      0.000 mm
Y      0.000 mm
+T     0.000 mm
-T     0.000 mm
Id: 01 point
X      63.676 mm
Y     -78.053 mm
+T     0.000 mm
-T     0.000 mm
Id: 02 line
X      10.684 mm
Y       6.884 mm
<     122.796
+T     0.000 mm
-T     0.000 mm
Id: 03 circle
X      50.237 mm
Y     -89.862 mm
r       7.341 mm
d      15.081 mm
+T     0.000 mm
-T     0.000 mm
Id: 04 dist.
X     -49.255 mm
Y      65.016 mm
Id: 05 angle
<1     86.429
<2    273.371
<3     93.571
<4    266.429
```

Communication

40 column example:

QC-2000 FEATURE PRINT OUT			
HEADER			
Date: _____ Time: _____			
Job: _____ Part: _____			
Operator: _____			
NO	FEATURE	ID	Dimension
001	point MM DD Ref 1 Abs 0	2a	X = 0.000 Y = 0.000 +T = 0.000 +T = 0.000
002	point MM DD Ref 1 Abs 0	2b	X = 63.676 Y = -78.053 +T = 0.000 +T = 0.000
003	line MM DD Ref 1 Abs 0	2c	X = 10.684 Y = 6.884 < = 122.796 +T = 0.000 +T = 0.000
004	circle MM DD Ref 1 Abs 0	2d	X = 50.237 Y = -89.862 r = 7.541 d = 15.081 +T = 0.000 +T = 0.000
005	dist	2e	X= -49.255 Y= 65.016
006	angle MM DD	2f	<1 = 86.429 <2 = 273.571 <3 = 93.571 <4 = 266.429

Communication

80 column example:

QC-2000 FEATURE PRINT OUT						
HEADER						
Date: _____			Time: _____			
Job: _____		Part: _____		Operator: _____		
NO	FEATURE	ID	Units	Position	Dimension	Form
001	point Ref 1 Abs 0	2a	MM	X= 0.000 Y= 0.000		+T= 0.000
002	point Ref 1 Abs 0	2b	MM	X= 63.676 Y=-78.053		+T= 0.000
003	line Ref 1 Abs 0	2c	MM DD	X= 10.684 Y= 6.884	< = 122.796	+T= 0.000 -T= 0.000
004	circle Ref 1 Abs 0	2d	MM	X= 50.237 Y=-89.862	r = 7.541 d = 15.081	+T= 0.000 -T= 0.000
005	dist	2e	MM		X= -49.255 Y= 65.016	
006	angle	2f	MM DD		< = 86.429 < = 273.571	

COMMUNICATIONS PROGRAM QC-2000 TO IBM COMPUTER

Communications Program

QC-2000 ← → *IBM computer*

This section explains how to create an interface between an IBM Personal Computer and a QC-2000. There are many manufacturers of computers and programming languages. Unfortunately they are not all compatible and it would be impossible to support every one of them. We will support GW-BASIC and IBM-BASIC on 100% IBM compatible computers. When using any other language or computer it is the users responsibility to check compatibility and change the program, cabling and system configuration accordingly.

You will require 2 items in addition to the program listed below.

1. A cable from the PC to the QC-2000.
2. IBM or "compatible" computer.

- NOTES:
1. The Quadra-Chek 2000 uses a DB 25 pin female connector with built-in nul.
 2. Most PC's use a DB 25 pin male connector for serial port. Do not use the DB 25 pin female input. This is for your parallel output and will not work with the Quadra-Chek.
 3. The IBM AT uses a 9 pin male D sub connector.
 4. Most printers use a DB 25 pin female connector.
 5. The QC-2000's voltage is selectable with 2 jumpers on the mother board near the connector. Some computers will require this to be set for the 12 volt position.

Communication

Use this first program example to establish communication from your computer to your Quadra-Chek. If using this example, please follow it exactly.(including line numbers). Once communication has been established, we will be making changes to the program.

*NOTE: This is a GWBASIC program written on an IBM "AT" Computer. Computers and software packages vary a great deal. If you cannot get this program to operate properly, refer to your computer manual and software manual for the proper commands.

```
10 REM PROGRAM TALK.BAS REVISION 8/15/91
20 CLEAR
30 CLS
40 PRINT "THIS IS A VERY SIMPLE PROGRAM TO TALK TO A QC-2000."
50 PRINT "IT WAS WRITTEN IN GWBASIC USING AN IBM AT COMPUTER."
60 PRINT "MAKE ANY NECESSARY CHANGES TO MATCH YOUR COMPUTER AND"
70 PRINT "BASIC SOFTWARE PACKAGE."
80 PRINT
90 PRINT "USING THE KEY EQUIVALENT LIST IN THE MANUAL YOU CAN EMULATE "
100 PRINT "THE QC-2000 FRONT PANEL."
110 PRINT "NOTE: DO NOT INCLUDE QUOTES"
120 PRINT
130 PRINT "ONCE YOU GET THIS PROGRAM TO RUN AND FEEL COMFORTABLE"
140 PRINT "WITH THE RESULTS YOU CAN EXPAND ON IT TO MEET YOU NEEDS."
150 PRINT
160 OPEN "COM1 : 4800,N,8,2,ASC,RS,DS" AS #1
170 PRINT #1, "QUIT":PRINT L$
180 I$=" "
190 PRINT "ENTER 'END' TO EXIT THIS PROGRAM"
200 INPUT "COMMAND ? " ,I$:IF I$= " " THEN I$="ENTER"
220 IF I$="END" THEN 290
230 IF I$="PRINT" THEN 310
260 PRINT #1, I$
270 GOTO 180
280 END
290 CLOSE #1:SYSTEM
310 PRINT "THIS PROGRAM IS NOT READY TO ACCEPT DATA FROM A QUADRA-
    CHEK":GOTO 180
```

Communication

Once communications have been established, make these changes to the program to read from the Quadra-Chek.

```
300 REM READING DATA FROM A QUADRA-CHEK
310 PRINT #1, "PRINT"
320 LINE INPUT #1,L$
330 PRINT L$
340 IF LOC(1)<1 THEN 180
350 GOTO 320
```

If you are ready to try something a little more advanced, then make these changes. This will allow you to enter whole numbers including the minus sign and decimals.

```
240 REM CHECK FOR NUMERIC ENTRY
250 IF LEFT$(I$,1)< CHR$(65) THEN 370
260 REM NUMERIC OUTPUT
370 REM CHECK FOR MINUS SIGN
380 IF LEFT$(I$,1)=CHR$(45) THEN GOSUB 440
390 N=LEN(I$)
400 FOR O=1 TO N
410 PRINT #1,MID$(I$,O,1)
420 NEXT O
430 GOTO 180
440 PRINT #1, "+/-"
450 I$=RIGHT$(I$,LEN(I$)-1)
460 RETURN
```

CONGRATULATIONS! You have now established full communication between your computer and Quadra-Chek. Feel free to make any necessary changes to match you computer and basic software package.

IBM is a registered trademark of International Business Machines.
PC is a trademark of International Business Machines.

SAMPLE PROGRAMS

GW-BASIC

```
10 REM      This is an example of a program written in GW-BASIC
20 REM      LINE 50 MUST be modified by the operator to match the
30 REM      computer and basic program in use!!!
40 REM
50 OPEN "COM1 : 4800,N,8,2,ASC,RS,DS" AS#1
60 PRINT #1,
70 PRINT #1,"PRINT"
80 LINE INPUT #1, X$ : LINE INPUT #1, Y$
90 PRINT X$ : PRINT Y$
100 CLOSE #1
110 END
```

IBM-BASIC

```
10 REM      This is an example of a program written in IBM-BASIC
20 REM      Line 50 MUST be modified by the operator to match the
30 REM      computer and basic program in use!!!
40 REM
50 OPEN "COM1 : 4800,N,8,2,RS,DS" FOR RANDOM AS #1
60 PRINT #1,
70 PRINT #1, "PRINT"
80 LINE INPUT #1, X$ : LINE INPUT #1, Y$
90 PRINT X$ : PRINT Y$
100 CLOSE #1
110 END
```

INPUT CODES

The QC-2000 may be controlled externally by certain predefined commands. These commands are ASCII strings (indicated by text surrounded by double quotes) which can be sent via the RS-232 port. When sent these strings should be terminated by a carriage return (ASCII 13).

The following are the commands:

1. **"POE ON"** Turns on the Print On Edge capability. The string "SUCCESSFUL" is sent back if Print On Edge is enabled.
2. **"POE OFF"** Turns off the Print On Edge capability. The string "SUCCESSFUL" is sent back if Print On Edge is disabled.
3. **"Q"** Zeros the Q axis.
4. **"PRINT X COMPLETE"** Prints out the X axis in the form:
 " X -0.0017 in"
 " X 100.02.03 deg"
 " X -100.0011E mm" the 'E' means a scale error occurred.
5. **"PRINT Y COMPLETE"** Prints out the Y axis in the form:
 " Y -0.0017 in"
 " Y 100.02.03 deg"
 " Y -100.0011E mm" the 'E' means a scale error occurred.
6. **"PRINT Q COMPLETE"** Prints out the X axis in the form:
 "Q -0.0017 in"
 " Q 100.02.03 deg"
 " Q -100.0011E mm" the 'E' means a scale error occurred.
7. **"PRINT VERSION NUMBER"** Prints out the version number in the form:
 " QC-2000 11.00".

RS-232 COMMANDS

Fast Download

The Fast Download function is accessible only through the RS-232 interface. This function provides a means to get position information at the greatest possible speed. When you send a Fast Download command to the QC-2000, it responds by sending the contents of the counters directly out the RS-232 port in binary format. The counters are read directly and the output is not influenced by any processing --no linear, nonlinear, or skew correction.

The purpose of this feature is mainly for users who wish to use the QC-2000 as feedback for a motor drive system. You must request a download with an ("F" followed by a carriage return) to send back a data packet .

Communication

The format of the output is:

| S_T | D_X | D_X | D_X | D_Y | D_Y | D_Y | C_S |

S_T = Start byte "S" = 53 hex

D_X = Data X channel: Most significant byte first, 2's complement format

D_Y = Data Y channel: Most significant byte first, 2's complement format

C_S = Checksum = sum D_X through D_Y mod 256

KEY EQUIVALENTS

The following list contains strings representing all of the front panel keys. When received via the RS-232 port, these strings have the same effect as if the key were actually being pressed.

1.	"POINT"	18.	"RECALL"
2.	"LINE"	19.	"FINISH"
3.	"CIRCLE"	20.	"QUIT"
4.	"DISTANCE"	21.	"ENTER"
5.	"ANGLE"	22.	"CANCEL"
6.	"SKEW"	23.	"+/-"
7.	"X"	24.	","
8.	"Y"	25.	"0"
9.	"MORE"	26.	"1"
10.	"INC/ABS"	27.	"2"
11.	"INCH/MM"	28.	"3"
12.	"CART/POL"	29.	"4"
13.	"EDGE/+"	30.	"5"
14.	"AUTO/MAN"	31.	"6"
15.	"PROGRAM"	32.	"7"
16.	"PRINT"	33.	"8"
17.	"STORE"	34.	"9"

ASCII CODES

8	backspace	46	.	84	T
9	horiz. tab	47	/	85	U
10	line feed	48	0	86	V
11	vert. tab	49	1	87	W
12	form feed	50	2	88	X
13	carr. ret.	51	3	89	Y
14	so	52	4	90	Z
15	si	53	5	91	[
16	dle	54	6	92	\
17	dcl	55	7	93]
18	dc2	56	8	94	^
19	dc3	57	9	95	_
20	dc4	58	:	96	`
21	nak	59	;	97	a
22	syn	60	<	98	b
23	etb	61	=	99	c
24	can	62	>	100	d
25	em	63	?	101	e
26	sub	64	@	102	f
27	esc	65	A	103	g
28	fs	66	B	104	h
29	gs	67	C	105	i
30	rs	68	D	106	j
31	us	69	E	107	k
32	space	70	F	108	l
33	!	71	G	109	m
34	"	72	H	110	n
35	#	73	I	111	o
36	\$	74	J	112	p
37	%	75	K	113	q
38	&	76	L	114	r
39	'	77	M	115	s
40	(78	N	116	t
41)	79	O	117	u
42	*	80	P	118	v
43	+	81	Q	119	w
44	,	82	R	120	x
45	-	83	S	121	y
				122	z

GLOSSARY

Column	Choose from 32,40 or 80 column printer.
Define Header	Enter information for heading.
DP3	MTI's 10 pin BCD format If "YES", overrides all other RS232 settings. If "NO", will not override settings.
Fast Download	The Fast Download function is accessible only through the RS-232 interface. This function provides a means to get position information at the greatest possible speed.
Form Feed	Select YES if you wish your printer to Form Feed.
POE (Print on Edge)	If "Yes", will print on Edge Crossing. If "NO", will not print on edge crossing.
Post Form	The purpose of a "Postform Character" is to output a control character such as, Line Feed, Carriage Return or any other ASCII Code control Character, after each page is printed.
Post Line	The purpose of a "Postline Character" is to output a control character such as, Line Feed, Carriage Return or any other ASCII Code control Character, after a line print.
Pre Form	The purpose of a "Preform Character" is to output a control character such as, Line Feed, Carriage Return or any other ASCII Code control Character, before each page is printed.
Pre Line	The purpose of a "Preline Character" is to output a control character such as, Line Feed, Carriage Return or any other ASCII Code control Character before a line print.
Set Number	Enter a number to set the sequential value in the left column of the printout (0-999)

QUADRA-CHEK 2000

SECTION VI SUPERVISOR SET UP

PREVIOUS READING

Before reading this section, you should read the Essential Information and Reference Guide sections. Please refer to these sections whenever you need background information.

ABOUT THIS SECTION

This section is intended for supervisory personnel. It describes the specifics of Supervisor Set Up which is an entry under the Setup menu. A special numeric code is needed to enter Supervisor Set Up. Note: Information about Serial Port Set Up is found in the Communications Section

SUPERVISOR SET UP

The following settings can be adjusted only in Supervisor Set Up:

- | | |
|--------------------|---|
| 1. Auto Setup? | - Auto Resolution set up. |
| 2. Tablet: No | - Used for Kurta Demo Tablet. |
| 3. Encoder Res | - Encoder resolution and type. |
| 4. Ref Marks: No | - Enables/disables Reference Mark function. |
| 5. Corrections... | - This includes: |
| a. LEC... | - Linear Error Compensation for each axis. |
| b. SLEC... | - Segmented Linear Error Compensation for each axis. |
| c. NLEC... | - Non Linear Error Compensation for each axis (Optional Feature). |
| 6. Prog. Lock: No | - Locking/Unlocking User Programs. |
| 7. Prescale? | - Axis prescale factor. |
| 8. Q Axis Type... | - Angular / linear axis. |
| 9. Keep Feats: Yes | - Retain or delete features between power cycles. |
| 10. Brightness # | - Controls the display brightness. |
| 11. Vertex Pt: No | - Enables/disables automatic display of the vertex point of an angle. |
| 12. Relations: Yes | - Enables/disables generation of distances and angles when using the Measure Magic feature. |
| 13. Ref Mark Cal.? | - Used to perform Reference Mark Calibration. |

ENTERING SUPERVISOR SET UP

To enter Supervisor Set Up use the following steps. A message is displayed prompting you to enter the Supervisor Code. Supervisor codes are available only through a dealer. Once these parameters are set, they normally do not need to be changed.

As you enter the code, the final keypress will grant you entry into Supervisor Set Up. Once you are in Supervisor Set Up use the Arrow keys to move up or down through the 10 entries. Each of the categories is described in the following pages.

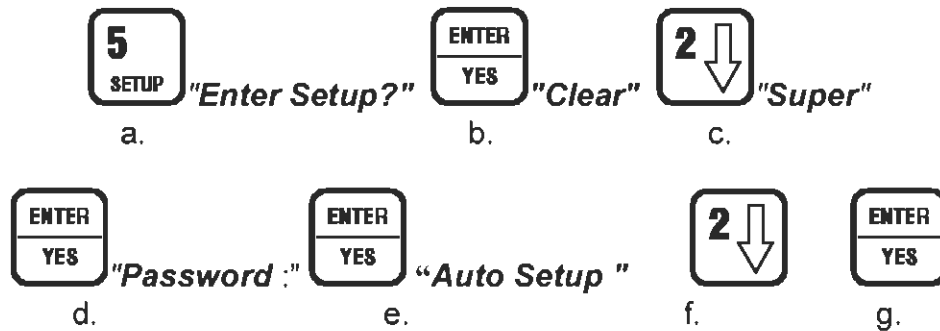

- a. Press the **SETUP** key on the QC-2000's Numeric Keypad. *"Enter Setup?"* appears in the message window.
- b. Press **ENTER**. *"CLEAR"* appears in the message window.
- c. Press the **DOWN ARROW** until *"SUPER"* appears in the message window.
- d. Press **ENTER**. *"Password"* appears in the message window.
- e. Enter the Password (Supervisors Code) using the Numeric Keypad, then press **ENTER**. *"Auto Setup"* appears in the message window.
- f. Press the **DOWN ARROW** to step thru the categories until the one you want appears in the message window.
- g. Press **ENTER** to select the category.

Shortcut: Once into **SETUP**, pressing the **Y** axis key will bring you to the end of all the menu items (Languages). Just press the **UP ARROW** once for "SUPER".

AUTO SETUP

The Auto Setup feature automatically sets the Default Units, the Display Resolution (Metric and English), the Encoder Resolution (X,Y, and Q) by entering a 2 digit number. (Please refer to next page for all possible automatic setups.)

The system has been factory set at the 01 Auto Setup. The dealer will set the Auto Resolution code to the customers' requirement.

To enter the Auto Setup number do the following steps:

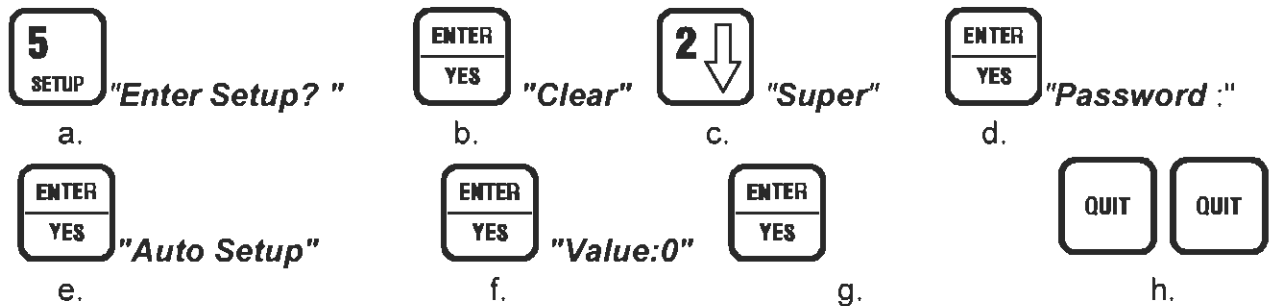

- a. Press the **SETUP** key on the QC-2000's Numeric Keypad. "Enter Setup?" appears in the message window.
- b. Press **ENTER**. "Clear" appears in the message window.
- c. Press the **DOWN ARROW** until "Super" appears in the message window.
OR Press the Y key then the **UP ARROW** once.
- d. Press **ENTER**. "Password" appears in the message window.
- e. Enter the Password (Supervisors Code) using the Numeric Keypad, then press **ENTER**. "Auto Setup" appears in the message window.
- f. Press **ENTER**. "Value: 0:" appears in the message window.
Enter the Auto Setup Code number using the Numeric Keypad (Refer to the Auto Setup Chart for the setup code). The number will show in the message window ("Value: XX").
- g. Press **ENTER**.
The word "Completed" will flash in the message window, then "Auto Setup" will appear.
- h. Press **QUIT** twice to exit setup and return to "Current Position".

Supervisor

AUTO SETUP (CONTD)

Select the appropriate setup code from the following chart for your system's resolution. If your encoders are metric, then your encoder resolution should be set in mm. (You can default your system to inches later). Set up numbers that include an asterisk *, have prescales. These numbers should be entered as shown, as they include the necessary prescaler.

AUTO SETUP CHART

Set Up #	Default Units	Disp. (mm)	Disp. (in)	X Encoder Resolution	Y Encoder Resolution	Q Encoder Resolution
00	METRIC	0.002	0.0001"	0.002	0.002	0.002
01	METRIC	0.001	0.00005"	0.001	0.001	0.001
02	METRIC	0.01	0.0005"	0.01	0.01	0.01
03	ENGLISH	0.002	0.0001"	0.0001"	0.0001"	0.0001"
04	ENGLISH	0.001	0.00005"	0.00005"	0.00005"	0.00005"
* 05	ENGLISH	0.001	0.00005"	0.000635	0.000635	0.000635
* 06	ENGLISH	0.001	0.00005"	0.00125	0.00125	0.00125
* 07	METRIC	0.001	0.00005"	0.00025	0.00025	0.00025
* 08	ENGLISH	0.001	0.00005"	0.00127	0.000635	0.00127
* 09	ENGLISH	0.002	0.00005"	0.000635	0.000635	0.000635
* 10	METRIC	0.002	0.0001"	0.002	0.00025	0.002
* 11	ENGLISH	0.002	0.00005"	0.001	0.00125	0.001
* 12	ENGLISH	0.002	0.0001"	0.00254	0.000635	0.00254
13	ENGLISH	0.1	0.005"	0.00425"	0.00425"	0.00425"
14	METRIC	0.002	0.0001"	0.001	0.001	0.001
15	METRIC	0.005	0.0002"	0.005	0.005	0.005
16	ENGLISH	0.005	0.0002"	0.0002"	0.0002"	0.0002"
89	METRIC	0.0004	0.00001"	0.0004	0.0004	0.0004
90	METRIC	0.0005	0.00002"	0.0005	0.0005	0.0005
* 91	ENGLISH	0.0002	0.00001"	0.000127	0.000127	0.000127
92	METRIC	0.0001	0.000005"	0.0001	0.0001	0.0001
93	ENGLISH	0.0002	0.00001"	0.00001"	0.00001"	0.00001"
94	ENGLISH	0.0005	0.00002"	0.00002"	0.00002"	0.00002"
95	METRIC	0.0002	0.00001	0.0002	0.0002	0.0002
101	METRIC	0.1	0.005"	0.1	0.1	0.1
102	METRIC	0.05	0.0002"	0.05	0.05	0.05

Note: You can convert any metric number to inches by dividing the number by 25.4.

TABLET YES/NO

The Tablet menu entry is used to enable the Kurta Demonstration Tablet. When "Tablet No" is displayed in the message window, press **CANCEL/NO** to set the Yes/No switch.

Note: If using the Tablet for demonstrations, it is best to use Auto Setup 13.

ENCODER RESOLUTION

The QC-2000 can be configured to accept signals from many different encoders. In order to display the correct measurements, the QC-2000 must be set for the actual resolution of the encoder in use. Note that the encoders are calibrated either in inch or metric, this must also be determined prior to entering the encoder information.

If the resolution you need is listed in the Auto Setup Chart, use the Auto Setup Procedure and skip this section.

To enter the Encoder Resolution do the following steps:

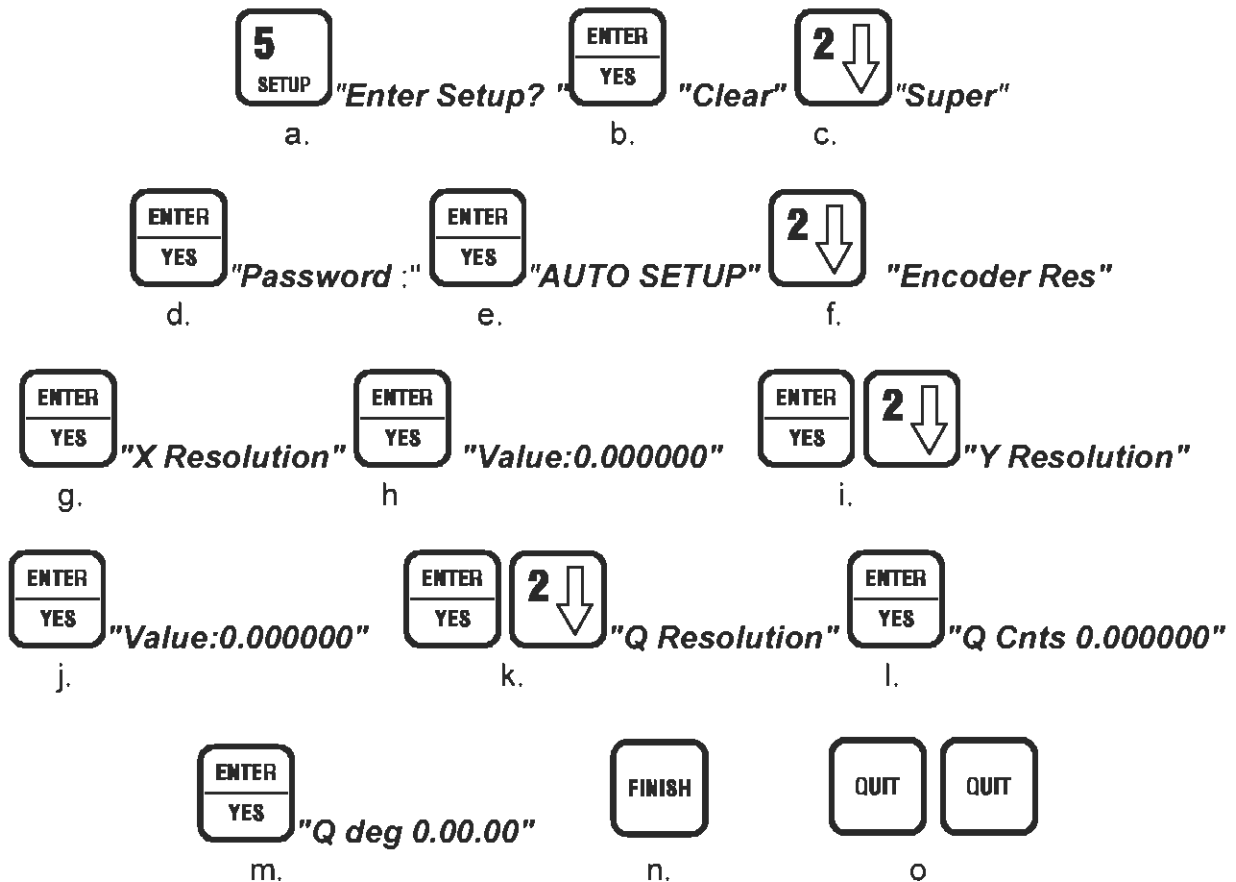

ENCODER RESOLUTION (CONTD)

- a. Press the **SETUP** key on the QC-2000's Numeric Keypad.
"Enter Setup?" appears in the message window.
- b. Press **ENTER** .
"Clear" appears in the message window.
- c. Press the **DOWN ARROW** until "Super" appears in the message window.
OR, Press **Y** then **UP ARROW** once.
- d. Press **ENTER** .
"Password" appears in the message window.
- e. Enter the Password (Supervisors Code) using the Numeric Keypad.
Press **ENTER**. "AUTO SETUP?" appears in the message window.
- f. Press the **DOWN ARROW** until "Encoder Res" appears in the message window.
- g. Press **ENTER** .
"X RESOLUTION?" appears in the message window.
- h. Press **ENTER** .
"Value: 0.00000000" appears in the message window.
Enter the X Encoder Resolution using the Numeric Keypad.
- i. Press **ENTER** and **DOWN ARROW**.
"Y RESOLUTION?" appears in the message window.
- j. Press **ENTER** .
"Value: 0.00000000" appears in the message window.
Enter the Y Encoder Resolution using the Numeric Keypad.
- k. Press **ENTER** and **DOWN ARROW**.
"Q RESOLUTION?" appears in the message window.
- l. Press **ENTER** .
"Q Cnts : 0.000000" appears in the message window.
Enter the Q Count using the Numeric Keypad.
- m. Press **ENTER** .
"Q Deg:" appears in the message window.
Enter the Q Degrees using the Numeric Keypad.
- n. Press **FINISH**.
- o. Press **QUIT** twice to exit menu and return to *Current Position*.

REFERENCE MARKS

Metronics Digital Readouts that support this feature will sense the Reference Mark in either direction. This gives you the flexibility to establish the direction to best fit your application.

This feature can be enabled or disabled at any time by pressing **ENTER/YES** or **CANCEL/NO** when "Ref Marks: Yes/No" appears in the message window. For more information, please refer to *Reference Mark Calibration* at the end of this chapter.

CORRECTIONS

LEC, **SLEC**, and **NLEC** are mutually exclusive methods of error correction. In the *Supervisor* menu, you'll see a menu item called "Corrections." Pressing **ENTER** when this item appears on the message window, will bring up a sub-menu with the four additional items, NONE, LEC, SLEC and NLEC. One of the items will be checked (factory default = NONE). Pressing **ENTER** when NONE is visible will check that item and disable all error corrections. Pressing **ENTER** when any other function is visible, will check that item and bring up the appropriate setup function of submenus.

SLEC

SLEC or Segmented Linear Error Correction, works by dividing each axis into several "segments," each of which have its own linear error correction factor and calibrated offset. You choose the number and location of segments. This feature allows you to compensate up to 20 segments of inaccuracies in your system.

An electronic correction system of this type must be physically tied to the machine travel. A correction at a given segment on the axis does not correspond to any other segment. In order to align the calibrated points with the physical travel of your machine, you must assign a landmark. This point (called "Machine 0,0") can be anywhere that is convenient. Once SLEC is installed on your machine, you **must** return to this same point every time you turn on your QC-2000.

Note: When the system is powered up, if either SLEC or NLEC is active, a prompt will indicate that the user should define the Machine Zero Point. If Reference Marks are installed, the prompt will be to "Cross References." If the Reference Marks are turned off, the prompt will be "Go To Mach. Zero."

The SLEC function must be provided with correction data in order to do its job. Therefore, all calibration points must be measured prior to setting up or using SLEC. There are several different types of "Calibration Equipment" which may be used to determine the calibration data. Lasers and precise calibrated artifacts are two examples.

TO ACQUIRE YOUR CALIBRATION POINTS:

For this demonstration we will call the device or system which indicates the "correct" or "nominal" position the "Calibration Standard." The position shown on the (uncorrected) DRO will be called the "Actual" reading.

1. Move to the machine zero point and zero the DRO. In a system with Reference marks, you may do this by recycling power (to cross reference marks again). If you move to 0,0 (on the DRO) you will be at the machine zero position.
2. Measure the calibration standard at several points along both axes and note the nominal (from the standard) and actual (from the DRO) reading for each point.

SLEC (CONTD)

- Determine the portions of the travel that need to be corrected and which portions should be grouped together into segments. Some portions of the travel may need more linear correction than others.

HOW TO DETERMINE A SEGMENT

Note: As you're measuring your points, it is recommended that you write them down or better yet make yourself a graph. You can use the graph as a visual, to help you select your segments.

A segment is a group of known points that may be combined together to form a single linear line. In the illustration below we have already acquired our calibration points and have charted them along with our Actuals. For sake of clarity, we have placed the graph under the chart and have used highly exaggerated numbers.

MAKING A GRAPH

Note: The graph below includes a 0 reference line with 2 lines above and below it. The +1 and -1 represents +/-10 and +/-2 represents +/-20. You can make your graph as you see fit so long as it includes a reference line.

- The first four calibration points (1-4) need no compensation and should be graphed at the 0 reference line. This will also represent the start point (*1st xxxxx*) of our compensation.
- Calibration point 5 was *Observed* at 480. This means we must add 20 to compensate for this error. Place a mark on the +2 line under calibration point 5.
- Point 6 has the same error. Place a mark on the +2 line under calibration point 6.
- Points 7, 8, and 9 need no compensation. Place marks on the 0 reference line.

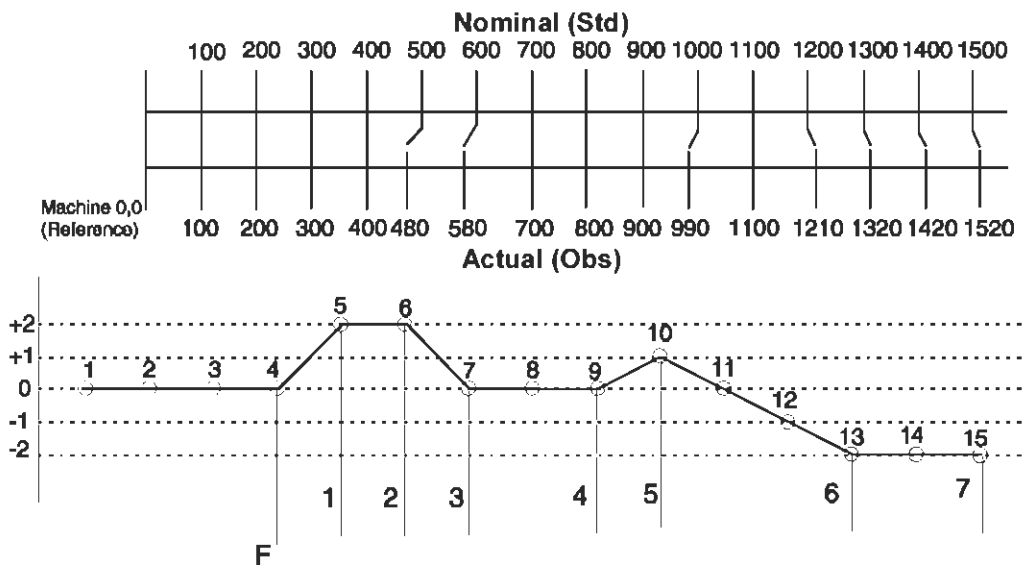

Figure 1

SLEC (CONTD)

- Calibration point 10 was *Observed* at 990. This means we must add 10 to compensate for the error. Place a mark on the +1 line under calibration point 10.
- Continue graphing all the observed points as shown above

GRAPHING THE SEGMENTS

- As mentioned earlier, a segment is a group of known points that may be combined together to form a single linear line. Looking a figure 1, you can see that no calibration was needed for points 1 though 4 (reference 0 line). These four points can be connected to form 1 line. Now, let's look at the next one.
- If you tried connecting points 4 and 6, then point 5 would not be connected. This means that our first segment must be from point 4 to point 5. (See figure 1).
- Since 5 and 6 are both on the +2 line, they will be connected.
- Draw a Line between points 6 and 7.
- Now let's take a look at points 7, 8 and 9. Notice that these marks can be connected using one single linear line. These three points connected together will form segment four.
- Draw a line between points 9 and 10.
- Now let's take a look at points 10, 11, 12 and 13. These marks can be connected using one single linear line making them *one* segment.
- Connect points 13, 14 and 15 using one line.

The numbers will be entered as follows:

First Point	1st X	= 400
Segment 1	<i>Obs</i>	= 480
	<i>Std</i>	= 500
Segment 2	<i>Obs</i>	= 580
	<i>Std</i>	= 600
Segment 3	<i>Obs</i>	= 700
	<i>Std</i>	= 700
Segment 4	<i>Obs</i>	= 900
	<i>Std</i>	= 900
Segment 5	<i>Obs</i>	= 990
	<i>Std</i>	= 1000
Segment 6	<i>Obs</i>	= 1320
	<i>Std</i>	= 1300
Segment 7	<i>Obs</i>	= 1520
	<i>Std</i>	= 1500

These seven (7) segments represent Segmented Linear Error Correction for fifteen (15) different points along the machine travel.

SETTING UP SLEC...

There are two setup functions: "X Axis SLEC" and "Y Axis SLEC." Since you may not need correction in both the Axes, they are listed as separate menu items. Each menu item must be selected and setup individually. To do this:

1. Press the **SETUP** key. "*Clear*" will appear.
2. Press the **Y** key. This will bring you to the end of the menu. (Languages).
3. Press the **Up** arrow. "*Super*". will appear.
4. Press **ENTER**. "*Password*" will appear.
5. Enter the password using the numeric keypad, then press **ENTER**.
6. Press the **DOWN ARROW** until "*Corrections*" appear (4x's).
7. Press **ENTER**. "*None*" will appear in the message window with a check mark next to it.
8. Press the **DOWN ARROW** key until SLEC appears in the message window
9. Press **ENTER**. A checkmark will be placed next to the word indicating that it is selected.
10. Press the **DOWN ARROW** until "*SLEC Setup*" appears in the message window.
11. Press **ENTER**. "*X SLEC: No*" appears in the message.
12. Press **ENTER** to turn it on. ("*X SLEC: Yes*).
13. Press the **DOWN ARROW** until "*X SLEC Setup*" appears in the message window.
14. Press **ENTER**. "*1st X: 0.00000*" appears in the message window. The first calibration point is the first GOOD point before compensation begins. In figure 1 our first point was 400.
15. Now use the numeric keypad to enter the location of the beginning of the first correction segment for the X axis ("first calibration point"), then press **ENTER**.
16. "*Obs X:*" appears. Enter the corresponding reading of the DRO which you noted earlier when collecting data. Press **ENTER**. In Segment 1, the *observed* is 480.
17. "*Std X:*" appears. Enter the nominal position of the beginning of the next segment. Press **ENTER**. In Segment 1, the *Standard* is 500.

18. Repeat these 2 steps until all corrections needed are complete. You can enter up to 20 correction segments.
19. Pressing **QUIT** at any time, will prompt the user to "Save SLEC." Responding with *Yes* will save the SLEC information just entered. Responding with a *No* will return you to the "X SLEC Setup" prompt.
20. Press the **DOWN ARROW** once "Y SLEC Setup" will appear.
21. Repeat steps 14 through 19 for Y Axis or Press **QUIT** to exit.

Use the same calibration standard and re-measure it to verify that the SLEC data has been correctly entered and that the corrections are as expected. Remember that the corrections will be the most precise at the calibration points you chose during the analysis.

Note: SLEC is not available for the third optional axis (Q). However, if the Q axis needs correction, the SLEC menu also includes *Q LEC Setup* on the bottom of the SLEC list. This function will work as it does in the regular LEC section.

LINEAR ERROR COMPENSATION

Linear Error Compensation allows you to correct for small linear errors in your comparator. An error is linear if it is the same wherever you are on the travel of your machine—if you find that you have 0.0002" error in 1 inch of travel, you will have 0.0012" error in any 6 inches of travel.

To use Linear Error Compensation you must first have a reference standard available for each axis of motion, namely X and Y. Next, you need to measure this standard on your comparator, noting the measured distance (or "observed length"). If your measurement is repeatedly too short or too long compared to the standard's length, then you need to use LEC.

CAUTION: You must first clear the previous error compensation from the axis you wish to correct before you attempt to calibrate that axis.

To clear LEC for an axis: enter a non-zero standard length (such as 1 inch) and then enter the same number (1 inch) for the observed length.

If you have determined that you need to use LEC, follow these steps:

1. Press the **SETUP** key, then press **ENTER**, "*Clear*" will appear.
2. Press the **Y** key. This will bring you to the end of the menu. (Languages).
3. Press the **Up** arrow. "*Super*". will appear.
4. Press **ENTER**. "*Password*" will appear.

Supervisor

5. Enter the password using the numeric keypad, then press **ENTER**.

LEC (CONTD)

6. Press the **DOWN ARROW** until "*Corrections*" appear (4x's).
7. Press **ENTER**. "*None*" will appear in the message window with a check mark next to it.
8. Press the **DOWN ARROW** key until **LEC** appears in the message window
9. Press **ENTER**. A checkmark will be placed next to the word indicating that it is selected.
10. Press the **DOWN ARROW** until "*LEC Setup*" appears in the message window.
11. Press **ENTER**. "*X LEC:?*" appears in the message.
12. Press **ENTER**
"*Std : 0.0000*" appears in the message window.
Enter the X standard length,
13. Press **ENTER**
"*Obs 0.0000*" appears in the message window.
Enter the X observed length.
14. Press **ENTER** and **DOWN ARROW**.
"*Y LEC?*" appears in the message window.
15. Press **ENTER** .
"*Std 0.0000*" appears in the message window.
Enter the Y standard length.
16. Press **ENTER** .
"*Obs :0.0000*" appears in the message window.
Enter the X observed length.
17. Press **ENTER**
18. Press **FINISH** then **QUIT** until *CURRENT POSITION* appears in the message window.

NON-LINEAR ERROR COMPENSATION

Non-Linear Error Compensation is an optional feature; please refer to the Option Section

LOCKING USER PROGRAMS

The Program Lock in the Supervisor Set Up allows you to lock (or unlock) all of the current User Programs. When the User Programs are locked none of them can be edited, deleted or printed. When the programs are unlocked it is possible that they may fall prey to a curious user.

It is not possible to selectively lock or unlock individual programs. The programs are locked and unlocked as a group. Programs that are created after the lock is set are not locked.

To lock or unlock the User Programs follow these steps:

- a. Follow steps a. thru e. of the Encoder Resolution paragraph.
- b. Press the **DOWN ARROW** until "*Prog. Lock No*" appears in the message window.
- c. Press **Yes** to lock the program and **No** to unlock the program.
- d. Press **FINISH** twice to exit menu.

PRESCALE

A prescale allows the operator a convenient and fast way of adjusting the values from the attached encoders. The number that is entered for the prescale (usually a fraction) is multiplied by the encoder resolution, there-by, giving a scaled encoder resolution. (This process could be used to compensate for thermal shrinkage.)

Use the following procedure to set the Prescaler axes.

- a. Press **SETUP**, "*Enter Setup?*" will be displayed, press **ENTER**.
- b. Press the **DOWN ARROW** until "*Super*" appears in the message window.
- c. Press **ENTER**, "*Password:*" will be displayed, enter the password.
- d. Press the **DOWN ARROW** until "*Prescale*" appears in the message window.
- e. Press **ENTER**, "*Value .0000000*" appears, enter the multiplier using the numeric keypad.
- f. Press **FINISH** twice to exit the menu.

The count from your encoders will now be multiplied by this fraction before any further processing by the QC-2000.

Q AXIS TYPE

Q Axis also known as The Electronic Protractor can be used for a screen rotation indicator or a linear movement indicator on an appropriate stage.

Q Axis Type in the Supervisor Setup Menu is used to define Q axis as either a Linear or rotary display. This is an *Optional* feature; please refer to the *OPTIONS* section of the manual for more information about the Electronic Protractor.

To define Axis Type:

1. Press **ENTER** when "Q Axis Type" appears in the message window.
2. "Angular" appears in the message window.
3. Press **ENTER** to select Angular or the **DOWN ARROW** to select "Linear"

KEEP FEATURES

The "Keep Feats Yes/No" in the Supervisor's menu determines whether features will be retained between power cycles. If Keep Features is "Yes" when the QC-2000 is turned off, all features will be retained. If Keep Features is "No" when the QC-2000 power is cycled, the features will be eliminated.

Use the following procedure to go to the Keep Features entry.

- a. Press **SETUP**, "Enter Setup?" will be displayed, press **ENTER**.
- b. Press the **DOWN ARROW** until "Super" appears in the message window.
- c. Press **ENTER**, "Password:" will be displayed. Enter the password.
- d. Press the **DOWN ARROW** until "Keep Feats Yes/No" appears in the message window.
- e. Press **ENTER/YES** to set Yes and No to set to No.
- f. Press **FINISH** twice to exit both menus.

BRIGHTNESS

This entry is used to adjust the message window character brightness from 0 to 6.

To adjust the brightness follow these steps.

- a. Enter the Supervisor Setup Menu.
- b. Press the **DOWN ARROW** until "Brightness #?" appears in the message window.
- c. Press **ENTER**, "Value: #" is displayed.
- d. Using the Numeric keypad, select a number from 0 to 6 to increase or decrease the light intensity of the window and axes (0 represents the brightest light and 6 represents the dimmest light intensity).
- e. Press the **ENTER** key to enter the new number.

Supervisor

- f. Press **FINISH** twice to exit both menus.

VERTEX

A vertex is the point at which two legs of an angle intersect. The QC-2000 includes a function that will automatically generate the vertex point when probing or constructing an angle.

Before you begin measuring Angles, you should decide if you want the **Vertex** point to be automatically generated for angle measurements. This function is factory defaulted as **NO** (disabled) and can be turned on in the Supervisor Setup Mode.

To enable/disable the Vertex function:

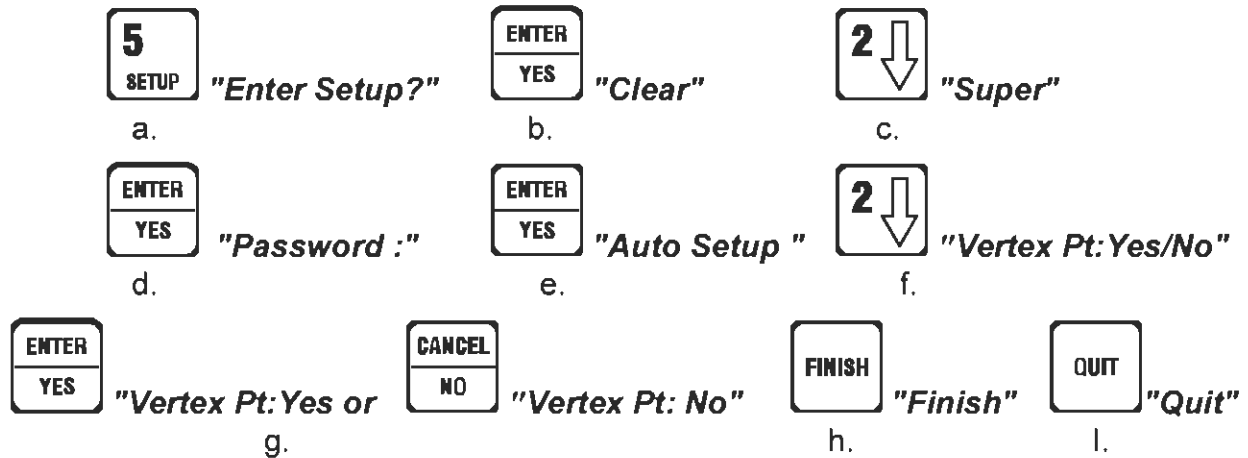

- a. Press the **SETUP (5)** key on the QC-2000's Numeric Keypad.
"Enter Setup?" appears in the message window.
- b. Press **ENTER** .
"Clear" appears in the message window.
- c. Press the **DOWN ARROW** until "Super" appears in the message window.
- d. Press **ENTER** .
"Password" appears in the message window.
- e. Enter the Password (Supervisors Code) using the Numeric Keypad.
"Auto Setup" appears in the message window.
- f. Press the **DOWN ARROW** to step thru the categories until the *Vertex: Yes/No* appears in the message window.
- g. Press **CANCEL/NO** to turn off the Vertex function or **ENTER/YES** to enable it.
- h. Press **FINISH** to complete the selection
- i. Press **QUIT** to exit the *SUPER* menu.

RELATIONS

This function is used in conjunction with Measure Magic. The QC-2000 allows the user to decide whether they wish to include *RELATIONS* (angles and distances) while using the Measure Magic function.

If Relations is OFF (**Relations: No**), Measure Magic will not generate any Distances or Angles. When it is ON, a 2 point line will be generated as a Distance, and Angles will now be generated if probing technique is correct. (See *Probing Techniques*)

When you receive your QC-2000 "**Relations**" is factory set at **Yes**. To turn Relations off, perform the following instructions.



"Enter Setup?"

a.



"Clear"

b.



"Super"

c.



"Password :"

d.



"Auto Setup "

e.



"Relations:Yes"

f.



"Relations: No"

g.



"Finish"

h.



"Quit"

i.

- a. Press the **SETUP (5)** key on the QC-2000's Numeric Keypad.
"Enter Setup?" appears in the message window.
- b. Press **ENTER** .
"Clear" appears in the message window.
- c. Press the **DOWN ARROW** until "Super" appears in the message window.
- d. Press **ENTER**.
"Password" appears in the message window.
- e. Enter the Password (Supervisors Code) using the Numeric Keypad.
"Auto Setup" appears in the message window.
- f. Press the **DOWN ARROW** to step thru the categories until *Relations:Yes* appears in the message window.
- g. Press **CANCEL/NO** to turn off Relations.
- h. Press **FINISH** to complete the selection
- i. Press **QUIT** to exit the *SUPER* menu.

REFERENCE MARKS

When using the Reference Mark on Linear Encoders, some control is necessary to maintain a repeatable machine reference. Some DRO's will only sense this mark when moving in a certain direction. This *pre-determined* direction may not yield the optimal performance in a given application.

Metronics Digital Readouts that support the Reference Mark will sense it in either direction. This gives you the flexibility to establish the direction to best fit your application. For some however, this may create a problem in obtaining a repeatable machine reference.

Since some reference marks have a certain thickness, referencing from left to right may give a different result than referencing from right to left. If you reference your linear encoders in either direction you will need to perform a Reference Mark Calibration. Calibrating will teach the 2000 the width of the Reference Mark, so that it may compensate for that width no matter which direction you reference from.

REFERENCE MARK CALIBRATION

Reference Mark Calibration is located under the *Supervisor Setup* menu. This calibration should be performed the first time you turn on the QC-2000 before any other setup functions are done.

To perform Reference Mark Calibration:

1. Press the **SETUP** key. "*Clear*" will appear.
2. Press the **Y** key. This will bring you to the end of the menu. (Languages).
3. Press the **Up** arrow. "*Super*". will appear.
4. Press **ENTER**. "*Password*" will appear.
5. Enter the password using the numeric keypad, then press **ENTER**.
6. Press the **Y** key. This will bring you to the end of the menu.
7. Ref. Mark Cal.? now appears on the alpha-numeric window
8. Press **ENTER** and follow instructions:
 - Cross X Ref. Mark
 - Cross X Again
 - Cross Y Ref. Mark
 - Cross Y Again

Once the procedure is performed, cycle the power (Turn off then on). Remember this calibration need only to be performed one time. The QC-2000 will remember and compensate for the width of the Reference Mark.

QUADRA-CHEK 2000

SECTION VII OPTIONS

OPTION SUMMARY

The QC-2000 may be equipped with the following options. These options are available at the time of equipment purchase or any time afterward. The installation of some options for QC-2000 systems in the field may require the system to be returned to Metronics for reconfigure of the software and hardware. For additional information, please refer to the specific options paragraph.

REMOTE KEYPAD

The Remote Keypad enables the operator to execute User Programs or simple key presses from up to nine feet away from the QC-2000.

PROGRAMMABLE FOOTSWITCH

The Programmable Footswitch is the little brother to the Remote Keypad. It has two keys that are available at the tap of a foot.

NON-LINEAR ERROR CORRECTION

NLEC is a program that automatically corrects for most non-linear measurement errors. Vibration or differential expansion error is not corrected by this program.

ELECTRONIC PROTRACTOR (Q AXIS)

The Electronic Protractor displays stage rotations via a Q axis on the QC-2000's screen. May also be configured for linear display.

EDGE DETECTOR

Edge Detection senses changes of light intensity from the comparators' view screen and interprets the change as a light to dark or dark to light edge crossing.

SMART EYE INPUT

This input is a level sensitive External Edge Detector.

QC-2000 SERIES:

	<u>2 Axis</u>	<u>Optical Edge Detector</u>	<u>Electronic Protractor</u>
QC-2200	X		
QC-2203	X	X(* Optional)	
QC-2205	X	X	
QC-2210	X		X
QC-2213	X	X(* Optional)	X
QC-2215	X	X	X

* Accepts input from other edge detection units.

KEYPAD AND FOOTSWITCH

The use of the 8 key or 14 key keypad or the FootSwitch option permits the operator to utilize the QC-2000 without having to press any front panel keys. The following section instructs you how to assign User Programs to the keys on the keypad. You may assign User Programs of any length to the keypad keys. If you are assigning a program to the Footswitch, use the 8 key keypad configuration.

The following describes how to set up the keypad.

1. Attach the Keypad to the QC-2000 by plugging the phone jack into the keypad receptacle on the back panel of the QC-2000.
2. Create the User Programs you wish to assign to the keypad. Refer to the User Programming Section of this manual for some sample programs.
3. Press the **5/SETUP** and **ENTER/YES** keys. Scroll to down to the *"Remote Keys"* and press **ENTER**. *"Use 8"* will display in the message window. Press **ENTER** again, *"A = ?"* will appear in the message window. Press **ENTER**, *"Key assignment"* will appear in the message window. To assign a front panel key, press that particular front panel key. To assign a program to that key, press **PROG**, enter the program number; then press **ENTER**.
4. Press the **FINISH** key to make keypad assignments permanent.

NOTE: If using the 14 key keypad do not assign a function to the PRO key, it will be used as a shift key. The 3,6,9 keys may be assigned functions just like the remote keys. Turn them on by scrolling down the Remote Keypad menu and pressing **ENTER**. You may assign programs and/or keys to them.

THE KEYPAD AND FOOTSWITCH (CONTD)

8 KEY KEYPAD

KEY A = (Program Assigned)
KEY B = (Program Assigned)
KEY C = (Program Assigned)
KEY D = (Program Assigned)
KEY E = (Program Assigned)
KEY F = (Program Assigned)
KEY G = (Program Assigned)
KEY P = (Program Key)

14 KEY KEYPAD

KEY A = (Program Assigned)
KEY B = (Program Assigned)
KEY C = (Program Assigned)
KEY D = (Program Assigned)
KEY E = (Program Assigned)
KEY F = (Program Assigned)
KEY G = (Program Assigned)
KEY a = (Program Assigned)
KEY b = (Program Assigned)
KEY c = (Program Assigned)
KEY d = (Program Assigned)
KEY e = (Program Assigned)
KEY f = (Program Assigned)
KEY g = (Program Assigned)

SPECIAL KEYS

SPECIAL Yes/No

3 = KEY ASSIGNMENT:
6 = KEY ASSIGNMENT:
9 = KEY ASSIGNMENT:

Figure 6-1. 8 and 14 key Keypads

The Footswitch is programmed in the same way as the Keypad except that there are only two programmable keys. The large foot pedal is the same as the A key on the Keypad. The narrow foot pedal is the same as the P key on the Keypad. See Figure 6-2.

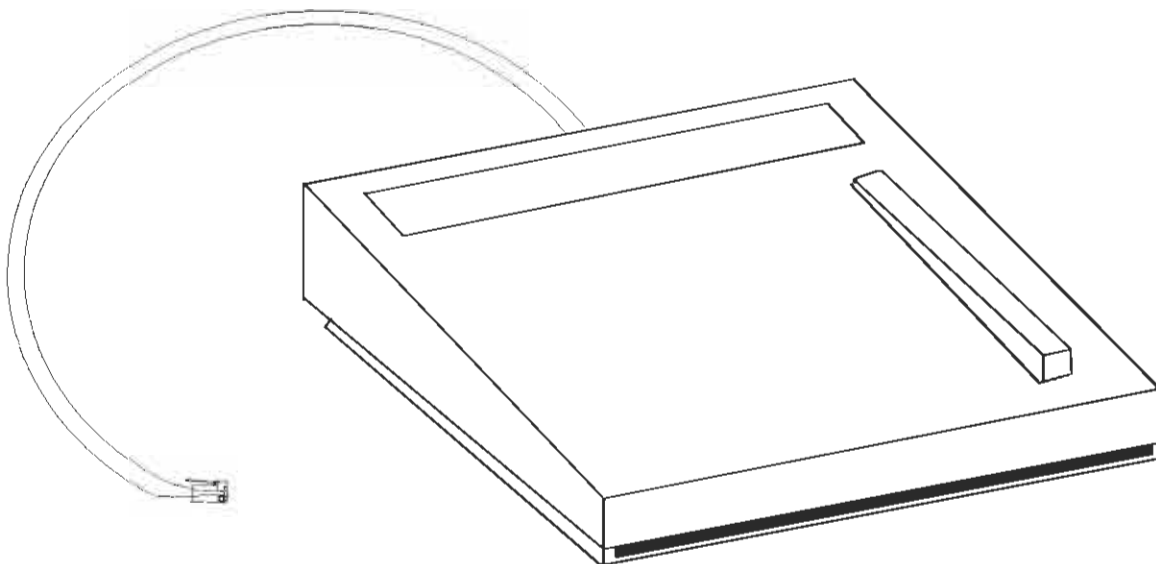

Figure 6-2 Footswitch.

REMOTE KEYPAD TEST

The Remote Test provides a quick test of the keypad keys to ensure that all are in working order.

1. Press **SETUP** and **ENTER**, then use the **DOWN ARROW** to step thru the entries until "TEST QC2000" appears in the message window.
2. Press **ENTER**, then press the **DOWN ARROW** until "Test Remote" is displayed.
3. Press **ENTER** again, "Begin Testing" is displayed in the window.
4. Press the keys on the Remote Keypad, when 8 key presses have been made the system will exit to the test menu.
5. Press **QUIT** to exit to the SETUP menu.
6. Press **QUIT** a second time to exit to the system operating menu.

ELECTRONIC PROTRACTOR

The Electronic Protractor is an extremely useful option providing you have encoders installed on the comparator. The Q axis is a 3rd axis in the QC-221X that may be defined as either a linear or rotary display. *This axis is used for display purposes only and is not a part of the skew.*

The Electronic Protractor displays stage rotations using the Q axis on the QC-221X's screen. If the system is configured as an optical comparator with a digital rotating screen, it is a rotary display. It can be used for a screen rotation indicator or a linear movement indicator on an appropriate stage.

A microscope is another configuration for the Electronic Protractor option. Here the Q Axis is used as a linear display to calculate the Z travel (simulating a height gage) plus having zeroing and information printing capabilities.

- Pressing the **7** key will toggle between the Q axis display (which is shown in the X axis) and whatever else is displayed.
- Pressing the **X** key while the Q axis is displayed, will zero the axis in either the absolute or incremental zero modes.
- Press the **1** key or the **PRINT** key while the Q axis is displayed, to print the axis' information.
- Pressing the **STORE** key while the Q axis is displayed, will convert the displayed axis value to an angle feature.
- Press the **MORE** key while the Q axis is displayed, to toggle the Q axis angular display mode between DD (decimal degrees) and DMS (degrees, minutes and seconds).
- The Q axis **angular** display is always in the range of -360 to +360 degrees at the current angular display resolution.
- The Q axis **linear** display is shown as an inch or millimeter value at the current linear display resolution.

ELECTRONIC PROTRACTOR (CONTD)

- Positive and negative roll-overs are monitored until the system power is cycled or the Q axis is zeroed.
-

The Q *angular or linear* display function is set in Supervisor's Setup.

The Q *encoder* resolution is also set in Supervisor's Setup.

- **Linear:**
The linear encoder resolution is entered in the same manner as any other axis.
- **Angular:**
Any change in the Q axis encoder while being prompted for the number of counts, causes the current number of counts to be displayed, thereby making it easy to determine the number of counts for a known quantity of degrees.

To set Q axis angular encoder resolution:



"Enter Setup?"

a.



"Clear"

b.



"Super"

c.



"Password :"

d.



"AUTO SETUP"

e.



"Encoder Res"

f.



"X Resolution"

g.



"Q Resolution"

h.



"Q Cnts 0.000000"

i.



"Q deg 0.00.00"

j.

Enter Previous counts

k.



l.



m.

- Press **SETUP**.
"Enter Setup?" is displayed in the message window.
- Press **ENTER**.
"Clear" is displayed in the message window.

ELECTRONIC PROTRACTOR (CONTD)

- c) Press the **DOWN ARROW** until "*Super*" is displayed.
- d) Press **ENTER**.
"*Password:*" is displayed in the message window.
- e) Enter the supervisor's password using the numeric keypad.
"*AUTO SETUP*" is displayed in the message window.
(If not, reenter the supervisor's password and press **ENTER**.)
- f) Press the **DOWN ARROW** until "*Encoder Res*" is displayed.
- g) Press **ENTER**.
"*X encoder res*" is displayed in the message window.
- h) Press **DOWN ARROW** until "*Q encoder res*" is displayed.
- i) Press **ENTER**.
"*Q Cnts #####*" is displayed in the message window.

At this point you may use the numeric keypad to enter a known number of scale counts (for a known number of degrees) or you may rotate the Q axis. The number of counts that the Q axis is rotated will be displayed in the message window.
- j) Press **ENTER**.
"*Q Deg ###.##.##*" is displayed in the message window.
- k) Using the numeric keypad, enter the number of degrees that correspond to the counts that you entered previously.
- l) Press **ENTER**.
- m) Press **FINISH** then **QUIT** to exit the supervisor and setup menus.

Perform linear Q axis setup as X or Y axis.

NON-LINEAR ERROR CORRECTION (NLEC)

A NOTE ON THEORY

NLEC is different from our standard LEC. Linear Error Compensation is an incremental error compensation. With LEC, if you move one inch along the X or Y axis the Linear Error Compensation will add or subtract the appropriate correction for one inch of travel. This occurs whenever you make a measurement no matter where on the travel you make it.

NLEC works by dividing your optical comparator's area into a grid of up to 20 x 20 blocks. You choose the number and the size of the grids. Each grid area has its own compensation factor built in, and the QC-2000 remembers each factor. This optional feature allows you to electronically compensate for any inaccuracies that your optical comparator may have developed.

The electronic correction grid must be physically tied to the machine travel—for example, the correction for the lower left corner of travel is only valid for that corner. In order to realign this electronic grid with the physical travel of your machine you must assign a landmark point on the machine. This point (called "NLEC 0,0") can be anywhere that is conveniently repeated when you turn "ON" the QC-2000.

Once NLEC is installed on your machine you must return to this same point and press ENTER every time you turn on your QC-2000. For convenience the QC-2000 can be left "ON" eliminating the need for re-establishing Machine 0,0.

However, if a power failure should occur, the Machine 0,0 must be re-established.

This section is intended for those who have purchased the NLEC option. You may skip this section if you do not have NLEC. Your dealer will have electronically compensated your comparator when he installed your QC-2000. Therefore, this section is for informational purposes; however, you may use it to perform periodic realignments if necessary.

The NLEC feature is a software program that will automatically correct for most small non-linear measurement equipment errors such as axis squareness or straightness. Non-linear errors caused by vibration or differential thermal expansion are not corrected by this program.

NON-LINEAR ERROR CORRECTION (CONTD)

As you know, optical comparators' tend to need frequent adjustment to maintain their accuracy. In order to correct this problem NLEC lets you map out the errors inherent in your comparator and remembers where these errors are located. Each time you pass through an error the QC-2000 automatically adds or subtracts the appropriate error factor.

The NLEC program must be provided with correction data in order to do its job. Figure 6-3, shows a NLEC "grid" as it might appear on a typical measuring stage.

Each small rectangle is delineated by four "stations." The grid may be plotted for a maximum of 20 X 20 rows and columns. If there are 3 rows and 4 columns, as in the preceding illustration, then there are 20 stations which must be qualified; that is, each station is a point which must be measured against a standard.

After NLEC setup is complete, the NLEC program corrects the DRO display by using a weighted average of the error at each of the four stations surrounding the current position.

NOTE: *If an error occurs while taking a measurement, it means your NLEC has been corrupted. You must clear the error and start over at 0,0.*

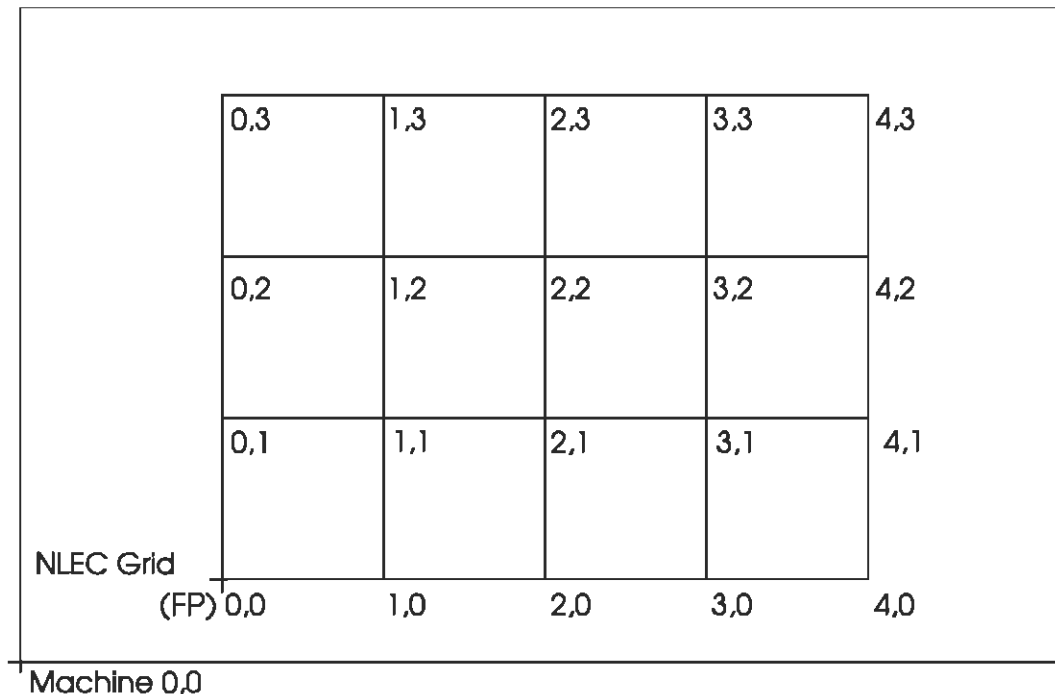

Figure 6-3. NLEC Grid.

NLEC SETUP

The NLEC setup requires the use of a glass "alignment grid" and before proceeding the grid must be manually aligned with the axis of the stage. After aligning the grid as closely as possible, follow these steps to set up NLEC.

- a. Press the **SETUP** key. "*Clear*" will appear.
- b. Press the **Y** key. This will bring you to the end of the menu. (Languages).
- c. Press the **Up** arrow. "*Super*". will appear.
- d. Press **ENTER**. "*Password*" will appear.
- e. Enter the password using the numeric keypad, then press **ENTER**.
- f. Press the **DOWN ARROW** until "*Corrections*" appear (4 x's).
- g. Press **ENTER**. "*None*" will appear in the message window with a check mark next to it.
- h. Press the **DOWN ARROW** key until **NLEC** appears in the message window
- i. Press **ENTER**. A check mark will be placed next to the word indicating that it is selected.
- j. Press the **DOWN ARROW** until "*NLEC Setup*" appears in the message window.
- k. Press **ENTER**. "*New NLEC*" appears in the message.
- l. Press **ENTER** to perform an initial setup.

(The NLEC menu has three choices: "*New NLEC*," "*Edit NLEC*," and "*Print NLEC*".) Use the following procedure to complete the initial setup:

1. At the prompt "# grid cols:" enter the number of columns and press **ENTER**. In the illustration (Figure 6-3.) the number of columns is 4
2. At the prompt "# grid rows:" enter the number of rows and press **ENTER**. In the illustration the number of rows is 3.
3. At the prompt "X size 1.000" enter the width of the grid columns and press **ENTER**. The default width is 1.000 mm or 0.0394 in.
4. At the prompt "Y size 1.000" enter the height of the grid rows and press **ENTER**. The default height is 1.000 mm or 0.0394 in.

Options

5. At the prompt "Go to NLEC 00" move the stage to a known point of the stage travel for both X and Y. One such point is the end of the travel if such a point is relatively fixed (Machine 0,0). Press **ENTER** to mark the NLEC 00 point.
6. At the prompt "Go to NLEC FP" move the stage to station 0, 0. This point is the lower left point of the glass alignment grid. Press **ENTER** to tell the system the position of the grid relative to the NLEC 00 point.
7. The prompt will now read "Station 1, 0", and the DRO will read the position of the crosshair relative to the position of station 1, 0. Move the stage to the position of station 1, 0. The DRO may show a small distance. This distance represents the non-linear error at that point of the grid. Press **ENTER** to save that error and continue.
8. The prompt will now read "Station 2, 0", and the DRO will read the position of the crosshair relative to the position of station 2, 0. Repeat steps 7 and 8 until all of the station errors have been entered being careful as you position each stage. Press **ENTER** after each stage.
9. After all stations have been entered, NLEC is automatically activated. To check the NLEC setup, turn off the QC2000, and turn it back on. At the prompt "Go to NLEC 00" move the stage to the NLEC 00 point and press **ENTER**. The system now should be capable of repeated accurate measurements of the alignment grid.

EDIT NLEC STATION ERRORS

- Enter the Super menu and down arrow to *NLEC...*
- Down arrow to "*Edit NLEC ?*" and press **ENTER**.
- Enter the X station number then press **ENTER**. Enter the Y station number and press **ENTER**. The X station error at that station is now displayed. If you need to modify the X station error, enter the new error value and press **ENTER**. The Y error is now displayed and may be modified in the same way.
- Repeat the procedure for each station that needs to be edited.

PRINT NLEC REPORT

- Enter the Super menu and down arrow to *NLEC...*
- Down arrow to "*Print NLEC ?*" and press **ENTER**.
- All the information about the NLEC setup will be printed.

QC2000 SMART EYE INPUT

VIEW FROM BACK OF UNIT

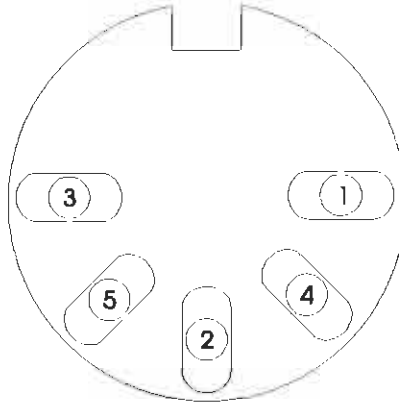

<u>PIN</u>	<u>DESCRIPTION</u>
1	Input signal (see note 1)
2	Ground
3	+5 V
4	Output Signal (see note 2)
5	No Connection

NOTE 1: This input is for a level sensitive, high active signal. It should be driven from an open collector device. There is a 10K ohm internal pull-up resistor.

NOTE 2: This output is an acknowledge signal. It outputs a low active TTL pulse.

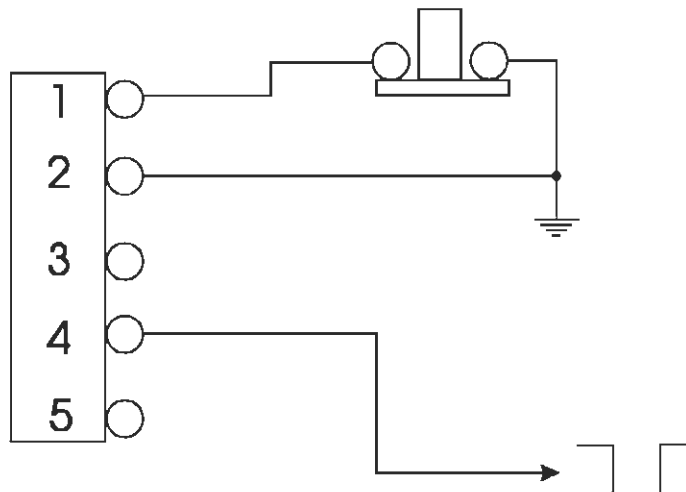

EDGE DETECTOR INSTALLATION

If you did not purchase the Edge Detector Option with your QC-2205, you may skip this section. It is included for the benefit of those who have purchased an Edge Detector.

WHAT IS EDGE DETECTION?

Edge detection permits the QC-2205 to recognize different levels of intensity of light from your comparator's view screen. Therefore, the QC-2205 can determine exactly where you crossed a shadow on the comparator's screen.

HOW EDGE DETECTION WORKS

Two fiber optic cables are attached from the QC-2000 to your comparator. One cable is for the Screen Sensor that is connected to the view screen and the other is for the Reference Sensor that points directly at the lamp.

The screen sensor measures the amount of light directly beneath it on the screen. The reference sensor provides a bright standard to measure the screen sensor against. The sensors are attached to the comparator using two fiber optic cables; the screen sensor connects to the view screen and the reference sensor points directly at the lamp.

THE SENSORS

After setting up your QC-2205 according to the Operator's Manual, examine the two black optic cables packaged with the QC-2205. Notice that one end of each cable contains a curved metal piece. This curved metal piece is the collecting end of the cable where the light from the screen or lamp enters the cable. The other end of the cable, the depositing end, plugs into your QC-2205.

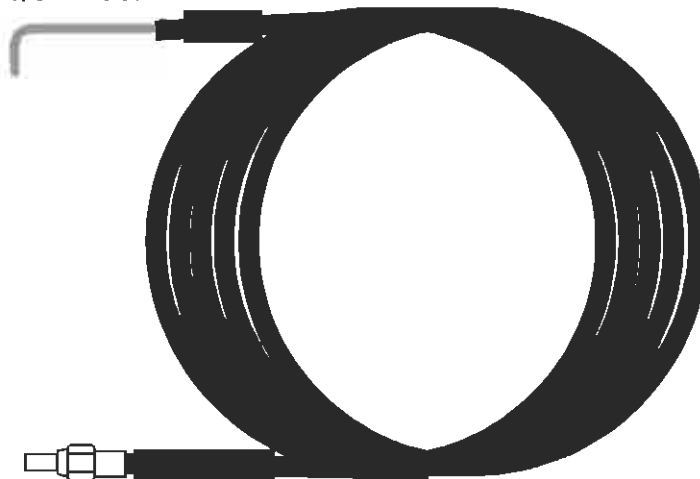

Figure 6-4. Fiber Optic Cable.

CONNECTING SENSORS TO THE QC-2205

On the back of your QC-2205, you will find two matching Photo Diodes. The top diode is for the screen sensor and the bottom one is for the reference sensor. Securely attach an optic cable to each connector.

CONNECTING THE SCREEN SENSOR TO THE COMPARATOR

Connect the collecting ends of each cable to its light source, namely the screen and the lamp.

Enclosed with your QC-2205 is a small plastic ruler. The ruler will be used to hold the screen sensor securely in place against the view screen.

- a. Place the plastic ruler under your comparator's chart clips so that the small hole in the ruler is located over an unobscured portion of your viewing screen.
- b. If necessary, gently clean the collecting end of the screen sensor with a soft lint free cloth.
- c. Place the tip of the screen sensor through the hole in the plastic ruler with the sensor's metal tip flush against the screen. Be careful not to scratch the view screen with the metal collecting tip.
- d. Secure the optic cable to the ruler using the plastic stick-on clamp provided.

CONNECTING THE REFERENCE SENSOR TO THE COMPARATOR

The reference sensor must point directly at the comparator's lamp; there are two ways to do this.

1. Secure the sensor so that it is outside the lamp housing, facing inward or,
2. Place the reference sensor inside the lamp housing.

The second approach is recommended, but the first is acceptable. Both methods are presented following a description of the optic cable characteristics.

CAUTIONS ABOUT FIBER OPTIC CABLES

1. The cable is not a wire and cannot be bent smaller than a one inch radius without effecting its performance.
2. The cable has a maximum safe operating temperature of 100 degrees centigrade.

PLACING THE REFERENCE SENSOR OUTSIDE THE LAMP HOUSING

The trick to is to secure the reference sensor tightly enough so that it cannot be moved by casually by bumping the optic cable. There is no easy method to do this because each comparator is different.

The reference sensor must point directly at the lamp and the excess optic cable must be kept out of the operator's way. Three methods we have used are:

1. Using stainless steel hose clamps around the condenser lens housing to secure the cable.
2. Snaking the cable through the lamp housing and securing it with nylon cable ties.
3. Drill 2 holes in the lamp housing and secure the optic cable to it using a metal tie pulled through the holes. This tie "hugs" the optic cable to the housing and points the sensor at the light source.

The optic cable must be secure, receive plenty of light, and stay relatively cool. Installing the cable so it receives cooling air from the lamp fan is a good idea since the cable maximum operating temperature is 100 degrees centigrade.

PLACING THE REFERENCE SENSOR INSIDE THE LAMP HOUSING

In many cases, it is easier to place the sensor cable inside the lamp housing but caution is required with respect to temperature. The same general restrictions apply, and the installation must provide a stable sample of the light source. This method provides a much cleaner installation because the cable is completely out of the way of the operator.

CHECKING THE SENSORS (INSTALL)

Before using the Edge detector, you should check the Reference Gain number and the light level of the screen sensor. This is done by entering *Install* under the **Cal** key. It will be displayed in the message window as *Scr #* *Ref #*.

THE SCREEN SENSOR

If it is above 11 or below 1, check to make sure that the depositing end of the reference sensor cable is firmly connected to the lower optic connector on the back of the QC-2205. If the number is still out of range, perform the following steps:

- a. If the number is above 11, there is not enough light entering the cable. Make sure that the tip of the cable is flush against the screen and the tip is clear of any obvious dirt or dust. Check to see that the comparator's light is turned on and that the screen sensor is located over a bright portion of the screen.
- b. If the number is below 1 too much light entering the optic cable. Try placing a color filter over either the comparator's lamp or screen to reduce the amount of light entering the sensor.

Most desired range for screen is between 3 and 7.

THE REFERENCE SENSOR

- a. If the number is above 11, not enough light entering the cable. Adjust the cable so the collecting end is pointing more directly at the light source. Continue adjusting the cable until the number is between 5 and 7.
- b. If the number is less than 1, too much light entering the optic cable. Turn the collecting end of the cable slightly away from the light source, so the number rises above 1.

Most Desired range for the reference sensor is between 5 and 8.

CALIBRATION

You are now ready to calibrate the Edge Detector. There are two calibration routines that should be performed, Auto Cal and Distance Cal. Refer to the Edge Detector Option for these functions, become familiar with them and know when you need to repeat them.

EDGE DETECTOR OPERATION

EDGE DETECTOR OPERATION

If you did not purchase the Edge Detector Option with your QC-2205, you may skip this section. It is included for the benefit of those who have purchased an Edge Detector.

This section gives a brief explanation of how Edge Detection works, along with several examples which illustrate the additional functionality an Edge Detector provides. These examples refer to the same demonstration part used in The QC-2205 Demonstration.

Before reading this section you should read Essential Information, The QC-2205 Demonstration, and, if necessary, the Reference Guide. Please refer to these sections when you need background information.

If the Edge Detector has not yet been installed, refer to Edge Detector Installation.

ABOUT EDGE DETECTION

The QC-2205 may be purchased with an Optical Edge Detector ("Edge Detector") which greatly enhances your comparator or other projection-based measuring machine. The Edge Detector senses changes in the comparator screen's brightness and interprets such a change as shadow edge crossing. The QC-2205 can recognize both light-to-dark and dark-to-light edge crossings. Please note that the Edge Detector requires a consistent bright and a consistent dark and as such will only perform well in the profile mode.

Although this section assumes that the Optical Edge Detector has been installed by a qualified technician, a brief description of the Edge Detector's workings is given to help you understand the required daily calibration. If the Edge Detector has not yet been installed, please refer to Edge Detector Installation, found in this section of the manual.

HOW EDGE DETECTION WORKS

Two fiber optic cables are attached from the QC-2205 to your comparator. One cable is for the Screen Sensor that is connected to the view screen and the other is for the Reference Sensor that points directly at the lamp. The Screen Sensor measures the amount of light directly underneath it on the screen. The Reference Sensor provides a bright standard against which to measure the Screen Sensor. The QC-2205, by comparing the relative intensities of these two light sources, can detect when the Screen Sensor crosses from dark to light or light to dark.

SELECTING THE EDGE DETECTOR

Before you can use the Edge Detector, you must tell the QC-2205 that you wish to change from the crosshairs to the Edge Detector.

To accomplish this press the **EDGE/+** key. The lights above the **EDGE/+** and the **AUTO/MAN** keys will be lit indicating that both the AUTO and EDGE Modes are selected.

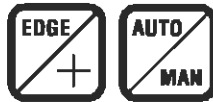

Now the QC-2205 knows that the Edge Detector (instead of the crosshairs) will be used to probed points.

AUTO MODE

There are two targeting modes available for Edge Detector, Auto Mode and Manual Mode.

- In Auto Mode, every edge crossing automatically acts as if you targeted the crossed point, and pressed ENTER.
- When in Manual Mode, the QC-2205 will still beep with every edge crossing and display the position, but you must press ENTER to confirm the point at every edge crossing.

For this section, we'll use Auto Mode. First, check that you are in Auto Mode. (If you followed the previous directions you are.) Look near the top right-hand side of the QC-2205's panel. If you see the light above the Auto/ MAN key is "ON" you are in Auto Mode. If not you're in Manual Mode.

If you are in Manual Mode, press the **AUTO/MAN** key.

Pressing **AUTO/MAN** again would put the QC-2205 back into Manual Mode. The **AUTO/MAN** key toggles the mode.

AUTO CAL

AUTO CAL is an abbreviation for "Automatic Calibration." An AUTO CAL is needed to teach the QC-2205 the light intensity levels to expect for both "dark and light". This should be performed every time you turn on your unit or change magnifications.

To perform AUTO CAL:



"Auto Cal "

a.



"In darkness?"

b.



"In light?"

c.

- a. Press the **4/CAL** key. "Auto Cal" is displayed in the message window.
- b. Press **ENTER**. "In darkness?" is displayed in the message window.
- c. Press **ENTER**. "In light?" is displayed in the message window. Move the screen sensor over a light portion of the screen.
- d. Press **ENTER**.

The Edge Detector now knows the difference between light and dark on your comparator's screen. This calibration should be repeated every time you turn on the QC-2205 and must be done every time you change magnification.

The display reads "Last Edge Cross", this is the last edge the optical sensor crossed which may be located anywhere on the part. "Current Position" is the current actual position of the crosshairs on the part.

DISTANCE CAL

Distance Cal (Distance Calibration) is located under the **4/CAL** key. The Distance Calibration operation fine tunes your Edge Detector to properly read the 'fuzzy' non-distinct edges. Be sure your image is well focused, because this will provide the best accuracy.

The Distance Calibration procedure should be performed when the light source of the comparator is not well columned. For instance, if you change from measuring a very flat part with distinct sharp shadows to a part with fuzzy edges, you must perform a Distance Calibration procedure. If you change from highly reflective parts to dark non-reflective parts or vice-versa, repeat the Distance Cal procedure.

You will need a sample part from those you are going to check. Position the part on the comparator, so it is aligned with the comparator's axis. Carefully measure the part using the crosshair (you must know the part's exact dimension).

Options

DISTANCE CAL (CONTD)

- a. Press the **4/CAL** key. *"Auto Cal"* is displayed in the message window.
- b. Press the **DOWN ARROW** key. *"Distance Cal"* is displayed in the message window.
- c. Press **ENTER**. *"Select axis, X/Y"* appears in the message window.
- d. Press the **"X "** or **"Y "** key. You may calibrate on either axis but not both.
- e. *"In darkness?"* appears in the message window.
Move the screen sensor over a dark portion of the screen and press **ENTER**.
- f. *"In light?"* appears in the message window.
Move the screen sensor over a light portion of the screen and press **ENTER**.
- g. *"Goal 0.00000"* appears in the message window.
Enter the part's exact dimension for the chosen axis.
- h. *"Ready For 1st.."* appears in the message window.
Make sure that the sensor is on the "outside" of the part. Press **ENTER**
- i. The message, *"Cross 1st edge"* appears.
Move the screen sensor across the sample's first edge.
- j. The message, *"Cross 2nd edge"* appears.
Move the screen sensor across the sample's second edge.
- k. The message, *"###.## ?"* appears on the screen.
 - l. If the value is not the part's exact dimension, press **NO**.
If an incorrect point is entered, press **NO** to cancel the result.
- m. Repeat steps i thru l until the number in the alphanumeric Display is the same as the number you programmed, or is an Acceptable Tolerance.
- n. A "CORRECT" message will appear if the number is the same.
Press **ENTER** then **QUIT**.
- o. If the result is an acceptable tolerance, press **QUIT** twice to ACCEPT the number and exit the procedure.

If a "Can Not Calibrate" message appears, your target value is too far from the actual measurement. Perform an AUTO CAL and repeat the DISTANCE CAL procedure.

CROSS CAL

- a. Press the **4/CAL** key.
"Auto Cal." is displayed in the message window.
- b. Press the **DOWN ARROW** until "Cross Cal." shows in the message window.
- c. Press **ENTER**.
"Probe Edge Circ" is displayed in the message window.
Probe the circle using the **edge detector** to target between 3 and 50 points on the circles circumference.
- d. Press **FINISH**.
"Probe Cross Circ" is displayed in the message window.
Probe the circle using the **crosshairs** to target between 3 and 50 points on the circle's circumference.
- e. Press **FINISH**.

You may now switch between the different targeting modes (Crosshairs, Edge and Auto Edge) even in a multi-point calculation and still obtain accurate results.

If you are in the middle of a multi-point measurement and accidentally enter an erroneous point, you can remove it by pressing **CANCEL** which will delete the last point entered. This feature becomes especially useful when you are in the Auto Mode.

INSTALL

The Install entry is used to check the light levels of the optic cables. Press the **4/CAL** key, then press the **DOWN ARROW** until you see "Install" in the message window. Press the **ENTER** key and check the numbers displayed in the message window.

If the number is above 11 or below 1, make sure that the depositing end of the screen sensor cable is firmly connected to the optic connector on the back of the QC-2205. If the number is still out of range perform steps a. and b.

- a. If the number is above 11, there is not enough light entering the cable. Make sure that the tip of the cable is flush against the screen and the tip is clear of any obvious dirt or dust. Check to see that the comparator's light is turned on and that the screen sensor is located over a bright portion of the screen.
- b. If the number is below 1 too much light entering the optic cable. Repeat steps 1 through 4. If the number is still below 1, place a color filter over either the comparator's lamp or screen to reduce the amount of light entering the sensor.